

Nokia X3-00 User Guide

Issue 2.0

Contents

Safety 4

Get started 6

Keys and parts 6

Insert the SIM card and battery 8

Insert and remove the memory card 9

Charge the battery 11

GSM antenna 12

Accessories 12

Switch it on 14

About your device 14

Network services 15

Access codes 15

Switch the device on and off 16

Standby mode 17

Navigate the menus 19

Lock the keys 20

Functions without a SIM card 21

Flight profile 21

Support and updates 21

Support 22

My Nokia 22

Download content 22

Software updates using your PC 23

Software updates over the air 23

Restore factory settings 24

Make it your device 25

Basic settings 25

Personalize your phone 27

Connect 30

Network provider services 35

Stay in touch 37

Make calls 37

Text and messages 41

Mail and Instant Messaging 46

Image and video 51

Capture images 51

Record videos 52

Camera and video settings 52

Gallery 53

Print images 54

Memory card 55

Entertainment 56

Listen to music 56

Web 63

Games and applications 66

Maps 67

Download maps 67

Maps and GPS 68

Extra services 69

Organize 70

Manage contacts 70

Business cards 72

Date and time	72
Alarm clock	72
Calendar	73
To-do list	73
Notes	74
Calculator	74
Countdown timer	74
Stopwatch	75

Green tips	75
-------------------	-----------

Save energy	75
Recycle	76
Learn more	76

Product and safety information	76
---------------------------------------	-----------

Index	86
--------------	-----------

Safety

Read these simple guidelines. Not following them may be dangerous or illegal. Read the complete user guide for further information.

SWITCH ON SAFELY



Do not switch the device on when wireless phone use is prohibited or when it may cause interference or danger.

ROAD SAFETY COMES FIRST



Obey all local laws. Always keep your hands free to operate the vehicle while driving. Your first consideration while driving should be road safety.

INTERFERENCE



All wireless devices may be susceptible to interference, which could affect performance.

SWITCH OFF IN RESTRICTED AREAS



Follow any restrictions. Switch the device off in aircraft, near medical equipment, fuel, chemicals, or blasting areas.

QUALIFIED SERVICE



Only qualified personnel may install or repair this product.

ACCESSORIES AND BATTERIES

Use only approved accessories and batteries. Do not connect incompatible products.

WATER-RESISTANCE

Your device is not water-resistant. Keep it dry.

Get started

Get to know your phone, insert the battery, SIM card, and memory card, and learn some important information about your phone.

Keys and parts

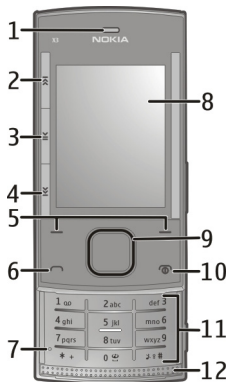

- 1 Earpiece
- 2 Music key: skip/rewind
- 3 Music key: play/pause
- 4 Music key: skip/forward
- 5 Left and right selection key
- 6 Call key
- 7 Microphone
- 8 Display
- 9 Navi™ key (scroll key)

- 10 End/Power key
- 11 Keypad
- 12 Loudspeaker

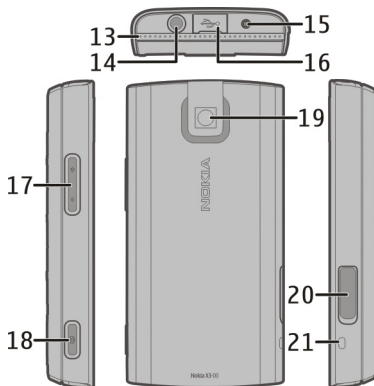

- 13 Loudspeaker
- 14 Nokia AV Connector (3.5 mm)
- 15 Charger connector
- 16 Micro USB cable connector
- 17 Volume keys
- 18 Capture key
- 19 Camera lens
- 20 Memory card slot
- 21 Wrist strap eyelet

Insert the SIM card and battery

Note: Switch off the power and disconnect the charger and any other device before removing the covers. Avoid touching electronic components while changing the covers. Always store and use the device with the covers attached.

The SIM card and its contacts can be easily damaged by scratches or bending, so be careful when handling, inserting, or removing the card.

- 1 Open the back cover, and remove it. Remove the battery.

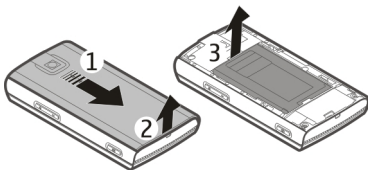

- 2 Open the SIM card holder. Insert the SIM card into the holder with the bevelled corner facing down and the contact surface area facing toward the contacts of the device. Close the SIM card holder.

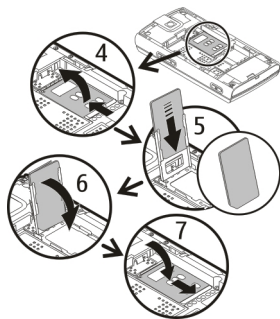

- 3 Line up the battery contacts, and insert the battery. Replace the back cover.

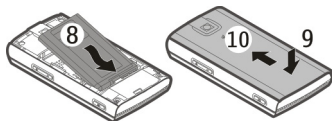

Insert and remove the memory card



Use only compatible microSD cards approved by Nokia for use with this device. Nokia uses approved industry standards for memory cards, but some brands may not be fully compatible with this device. Incompatible cards may damage the card and the device and corrupt data stored on the card.

Your device supports microSD cards with a capacity of up to 8 GB. The size of a single file must not exceed 2 GB.

Insert the memory card

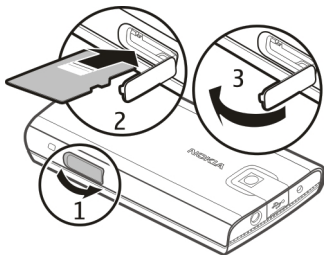

- 1 Open the cover of the memory card slot.
- 2 Insert the card into the memory card slot with the contact surface facing down, and press until it locks into place.
- 3 Close the cover of the memory card slot.

Remove the memory card

Important: Do not remove the memory card during an operation when the card is being accessed. Doing so may damage the memory card and the device, and corrupt data stored on the card.

You can remove or replace the memory card without switching the device off.

- 1 Ensure that no application is currently accessing the memory card.
- 2 Open the cover of the memory card slot.
- 3 Press the memory card slightly in to release the lock, and remove the card.

Charge the battery

Your battery has been partially charged at the factory. If the device indicates a low charge, do the following:

- 1 Connect the charger to a wall outlet.

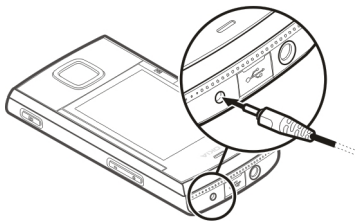

- 2 Connect the charger to the device.
- 3 When the battery is fully charged, disconnect the charger from the device, then from the wall outlet.

You can also charge the battery with a USB data cable connected to a compatible computer.

- 1 Connect the USB cable to a USB port of a computer and to your device.
- 2 When the battery is fully charged, disconnect the USB cable.

You do not need to charge the battery for a specific length of time, and you can use the device while it is charging. If the battery is completely discharged, it may take several minutes before the charging indicator appears on the display or before any calls can be made.

Charging the device while listening to the radio may affect the quality of reception.

GSM antenna



Your device may have internal and external antennas. Avoid touching the antenna area unnecessarily while the antenna is transmitting or receiving. Contact with antennas affects the communication quality and may cause a higher power level during operation and may reduce the battery life.

The figure shows the GSM antenna area marked in grey.

Accessories

Connect a USB cable

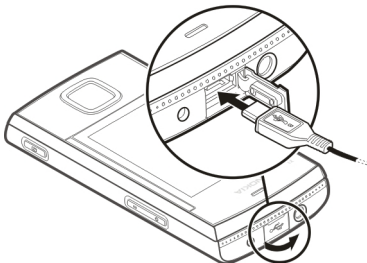

Open the cover of the USB connector, and connect the USB cable to the device.

Headset

Warning:

When you use the headset, your ability to hear outside sounds may be affected. Do not use the headset where it can endanger your safety.

When connecting any external device or any headset, other than those approved by Nokia for use with this device, to the Nokia AV Connector, pay special attention to volume levels.

Do not connect products that create an output signal as this may cause damage to the device. Do not connect any voltage source to the Nokia AV Connector.

Strap

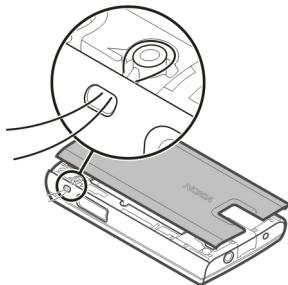

Thread a strap as shown in the picture and tighten it.

Switch it on

Learn how to switch on your phone, and how to use the basic functions.

About your device

The wireless device described in this guide is approved for use on the GSM 850, 900, 1800, and 1900 MHz networks. Contact your service provider for more information about networks.

Your device may have preinstalled bookmarks and links for third-party internet sites and may allow you to access third-party sites. These are not affiliated with Nokia, and Nokia does not endorse or assume liability for them. If you access such sites, take precautions for security or content.

Warning:

To use any features in this device, other than the alarm clock, the device must be switched on. Do not switch the device on when wireless device use may cause interference or danger.

When using this device, obey all laws and respect local customs, privacy and legitimate rights of others, including copyrights. Copyright protection may prevent some images, music, and other content from being copied, modified, or transferred.

Make back-up copies or keep a written record of all important information stored in your device.

When connecting to any other device, read its user guide for detailed safety instructions. Do not connect incompatible products.

The images in this guide may differ from your device display.

Refer to the user guide for other important information about your device.

Network services

To use the device you must have service from a wireless service provider. Some features are not available on all networks; other features may require that you make specific arrangements with your service provider to use them. Network services involve transmission of data. Check with your service provider for details about fees in your home network and when roaming on other networks. Your service provider can explain what charges will apply.

Your service provider may have requested that certain features be disabled or not activated in your device. If so, these features will not appear on your device menu. Your device may also have customized items such as menu names, menu order, and icons.

Access codes

To set how your phone uses the access codes and security settings, select **Menu > Settings > Security > Access codes**.

- The security code helps to protect your phone against unauthorized use. The preset code is 12345. You can change the code and set the phone to request the code. Some operations require the security code regardless of the settings, for example if you want to restore the factory settings. Keep the code secret and in a safe place separate from your phone. If you forget the code and your phone is locked, your phone will require service and additional charges may apply. For more information, contact a Nokia Care point or your phone dealer.
- The PIN (UPIN) code, supplied with the SIM (USIM) card, helps to protect the card against unauthorized use.
- The PIN2 (UPIN2) code, supplied with some SIM (USIM) cards, is required to access certain services.
- PUK (UPUK) and PUK2 (UPUK2) codes may be supplied with the SIM (USIM) card. If you enter the PIN code incorrectly three times in succession, you are asked for the PUK code. If the codes are not supplied, contact your service provider.
- The restriction password is required when using the call restriction service to restrict calls to and from your phone (network service).

16 Switch it on

- To view or change the security module settings for the browser, select **Menu > Settings > Security > Security module sett..**

Switch the device on and off

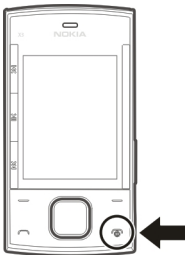

Switch on and off

Press and hold the power key.

Enter the PIN code

If requested, enter the code PIN code (displayed as ****).

Set the time and date

If requested, enter the date, the local time, and the time zone and the daylight saving time of your location.

When you switch on your device for the first time, you may be prompted to get the configuration settings from your service provider (network service). For more information, contact your service provider.

Standby mode

When the phone is ready for use, and you have not entered any characters, the phone is in the standby mode.

Display

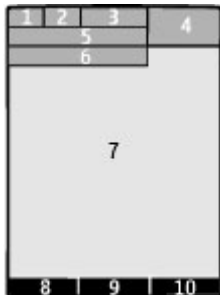

- 1 Signal strength of the cellular network 
- 2 Battery charge status
- 3 Indicators
- 4 Clock
- 5 Name of the network or the operator logo
- 6 Date (only if the Home screen is deactivated)
- 7 Display
- 8 Function of the left selection key
- 9 Function of the Navi key (scroll key)
- 10 Function of the right selection key

You may change the function of the left and right selection key. [See "Left and right selection keys," p. 28.](#)

18 Switch it on

Home screen

The home screen displays a list of selected features and information that you can directly access.

Select **Menu** > **Settings** > **Display** > **Home screen**.

Activate the home screen

Select **Home screen mode**.

Organize and personalize the home screen

Select **Personalize view**.

Select a key to activate the home screen

Select **Home screen key**.

Navigate in the home screen

Scroll up or down to navigate in the list, and select **Select**, **View**, or **Edit**. The arrows indicate that further information is available.

Stop navigating

Select **Exit**.

Shortcuts

When your device is in the standby or home screen mode, you can use the following shortcuts.

List missed, received, and dialled calls

Press the call key. To make a call, scroll to the number or name, and press the call key.

Start the web browser

Press and hold **0**.

















Call the voice mailbox

Press and hold **1**.

Use other keys as shortcuts

See "[Dialing shortcuts](#)," p. 38.

Indicators

	You have unread messages.
	You have unsent, canceled, or failed messages.
	The keypad is locked.
	The device does not ring for incoming calls or text messages.
	An alarm is set.
	The device is registered to the GPRS or EGPRS network.
	A GPRS or EGPRS connection is open.
	The GPRS or EGPRS connection is suspended (on hold).
	Bluetooth connectivity is activated.
	A GPS signal is available (external GPS antenna necessary).
	No GPS signal available (external GPS antenna necessary).
	If you have two phone lines, the second line is in use.
	All incoming calls are forwarded to another number.
	Calls are limited to a closed user group.
	The currently active profile is timed.
	A headset is connected to the device.
	The device is connected to another device using a USB data cable.

Navigate the menus

The phone offers you an extensive range of functions that are grouped into menus.

- 1 To access the menu, select **Menu**.
- 2 Scroll through the menu, and select an option (for example, **Settings**).

20 Switch it on

- 3 If the selected menu contains further submenus, select one (for example, **Call**).
- 4 Select the setting of your choice.
- 5 To return to the previous menu level, select **Back**.
To exit the menu, select **Exit**.

To change the menu view, select **Options** > **Main menu view**. Scroll right, and select from the available options.

To rearrange the menu, select **Options** > **Organize**. Scroll to the menu item to be moved, and select **Move**. Scroll to where you want to move the menu item, and select **OK**. To save the change, select **Done** > **Yes**.

Lock the keys

Lock the keypad to prevent accidental keypresses.

Lock the keypad

Select **Menu**, and press * within 3.5 seconds.

Unlock the keypad

Select **Unlock**, and press * within 1.5 seconds. If requested, enter the lock code.

Answer a call when the keypad is locked

Press the call key. When you end or reject a call, the keypad locks automatically.

Further features are Automatic keyguard and Security keyguard. [See "Phone settings," p. 25.](#)

When the device or keypad is locked, calls may be possible to the official emergency number programmed into your device.

Functions without a SIM card

Some functions of your phone may be used without inserting a SIM card, such as Organizer functions and games. Some functions appear dimmed in the menus and cannot be used.

Flight profile

Use the Flight profile in radio sensitive environments to deactivate all radio frequency functions. You still have access to offline games, the calendar, and phone numbers. When the Flight profile is active,  is displayed.

Activate the Flight profile

Select Menu > Settings > Profiles > Flight > Activate or Customize.

Deactivate the Flight profile

Select any other profile.

Warning:

With the Flight profile you cannot make or receive any calls, including emergency calls, or use other features that require network coverage. To make calls, you must first activate the phone function by changing profiles. If the device has been locked, enter the lock code.

If you need to make an emergency call while the device is locked and in the Flight profile, you may be also able to enter an official emergency number programmed in your device in the lock code field and select 'Call'. The device will confirm that you are about to exit Flight profile to start an emergency call.

Support and updates

Nokia helps you in many ways to gain the most benefit from your device.

You can find the model number of your device on the back cover.

Support

When you want to learn more about how to use your product or you are unsure how your device should function, see the user guide or see the support pages at www.nokia.com/support or your local Nokia website, or with a mobile device, www.nokia.mobi/support, the Help application in the device, or the user guide.

If this does not resolve your issue, do one of the following:

- Restart the device: switch off the device, and remove the battery. After about a minute, replace the battery, and switch on the device.
- Restore the original factory settings as explained in the user guide.
- Update your device software regularly for optimum performance and possible new features, as explained in the user guide.

If your issue remains unsolved, contact Nokia for repair options. See www.nokia.com/repair, or in Latin America, www.nokia-latinoamerica.com/centrosdeservicio. Before sending your device for repair, always back up the data in your device.

My Nokia

Receive free tips, tricks, and support for your Nokia phone, plus free trial content, interactive demonstrations, a customized web page, and news about the latest Nokia products and services.

Get the most out of your Nokia phone and register at My Nokia today! For more information and availability in your region, see www.nokia.com/mynokia.

Download content

You may be able to download new content (for example, themes) to your phone (network service).

Important: Use only services that you trust and that offer adequate security and protection against harmful software.

For the availability of different services and pricing, contact your service provider.

Software updates using your PC

Nokia Software Updater is a PC application that enables you to update your device software. To update your device software, you need a compatible PC, broadband internet access, and a compatible USB data cable to connect your device to the PC.

To get more information, to check the release notes for the latest software versions, and to download the Nokia Software Updater application, see www.nokia.com/softwareupdate, or in Latin America, www.nokia-latinoamerica.com/nsu.

To update the device software, do the following:

- 1 Download and install the Nokia Software Updater application to your PC.
- 2 Connect your device to the PC using a USB data cable, and select **PC Suite**.
- 3 Open the Nokia Software Updater application. The Nokia Software Updater application guides you to back up your files, update the software, and restore your files.

Software updates over the air

Your service provider may send phone software updates over the air directly to your phone (network service). This option may not be available, depending on your phone.

Downloading software updates may involve the transmission of large amounts of data (network service).

Make sure that the device battery has enough power, or connect the charger before starting the update.

Warning:

If you install a software update, you cannot use the device, even to make emergency calls, until the installation is completed and the device is restarted. Be sure to back up data before accepting installation of an update.

Software update settings

This option may not be available, depending on your phone.

To allow or disallow automatic software updates, select **Menu > Settings > Phone > Phone updates > Automatic SW update**.

Request a software update

- 1 Select **Menu > Settings > Phone > Phone updates** to request available software updates from your service provider.
- 2 Select **Current softw. details** to display the current software version and check whether an update is needed.
- 3 Select **Downl. phone softw.** to download and install a software update. Follow the instructions on the display.
- 4 If the installation was canceled after the download, select **Install softw. update** to start the installation.

The software update may take several minutes. If there are problems with the installation, contact your service provider.

Restore factory settings

To restore the phone back to factory settings, select **Menu > Settings > Rest. factory sett.** and from the following:

Restore settings only — Reset all preference settings without deleting any personal data.

Restore all — Reset all preference settings and delete all personal data, such as contacts, messages, media files, and activation keys.

Make it your device

Set up your device, personalize it, and connect it in several ways.

Basic settings

Phone settings

Select **Menu > Settings and Phone**.

Select from the following:

Language settings — To set the language of your device, select **Phone language** and a language. To set the language of your device according to the information on the SIM card, select **Phone language > Automatic**.

Memory status — View the memory consumption.

Automatic keyguard — The keypad is locked automatically after a preset time delay when the device is in the standby mode or home screen and no function has been used.

Security keyguard — Set the device to request the security code to unlock the keypad.

Voice recognition — Set up voice commands, or start voice recognition training.

Flight query — Set the device to prompt for the Flight profile when you switch the device on. In the Flight profile, all radio connections are closed.

Phone updates — Allow software updates from your service provider (network service). The available options may vary.

Operator selection — Manually select which network to use.

Help text activation — Set the device to display help text .

Start-up tone — Play a tone when you switch the device on .

Confirm SIM actions — Access additional network services from your SIM card. This option may not be available, depending on your SIM card.

Security settings

Select **Menu** > **Settings and Security**.

When security features that restrict calls are in use (such as call barring, closed user group, and fixed dialing), calls may be possible to the official emergency number programmed into your device. Call restrictions and call forwarding cannot be active at the same time.

Select from the following:

PIN code request or **UPIN code request** — Set the device to request for the PIN or UPIN code every time the device is switched on. Some SIM cards do not allow the code request to be deactivated.

Call restrictions — Restrict incoming calls to and outgoing calls from your device (network service). A barring password is required.

Fixed dialing — Restrict your outgoing calls to selected phone numbers if supported by your SIM card. When fixed dialing is activated, GPRS connections are not possible except while sending text messages over a GPRS connection. In this case, the recipient's phone number and the message centre number must be included in the fixed dialing list.

Closed user group — Define a group of people whom you can call and who can call you (network service).

Security level — To request the security code whenever a new SIM card is inserted into the device, select **Phone**.

Access codes — Change the security code, PIN code, UPIN code, PIN2 code, or barring password.

PIN2 code request — Set the device to request the PIN2 code when using a specific device feature protected by the PIN2 code. Some SIM cards do not allow the code request to be deactivated. This option may not be available depending on your SIM card. For details, contact your service provider.

Code in use — Display and select the type of PIN code to be used.

Authority certificates or **User certificates** — View the list of the authority or user certificates available on your device.

Security module sett. — View Secur. module details, activate **Module PIN request**, or change the module PIN and signing PIN.

Personalize your phone

Give your phone a personal touch with ringing tones, display backgrounds, and themes. Add shortcuts for your preferred features, and attach enhancements.

Profiles

Your phone has various setting groups called profiles, which you can customize with ringing tones for different events and environments.

Select **Menu > Settings > Profiles**, the desired profile, and from the following options:

Activate — to activate the selected profile

Customize — to change the profile settings

Timed — to set the profile to be active for a certain time. When the time set for the profile expires, the previous profile that was not timed becomes active.

Themes

A theme contains elements for customizing your phone.

Select **Menu > Settings > Themes** and from the following options:

Select theme — Open the **Themes** folder, and select a theme.

Theme downloads — Open a list of links to download more themes.

Tones

You can change the tone settings of the selected active profile.

Select **Menu > Settings > Tones**. You can find the same settings in the **Profiles** menu.

Lights

To activate or deactivate light effects associated with different phone functions, select **Menu > Settings > Lights**.

Display

Select **Menu > Settings > Display** and from the following:

Wallpaper — to add a background image for the home screen mode

Home screen — to activate, organize, and personalize the home screen mode

Home screen font col. — to select the font color for the home screen mode

Navigation key icons — to display the scroll key icons in the home screen mode

Notification details — to display details in missed call and message notifications

Slide animation — to display an animation when you open or close the slide

Screen saver — to create and set a screen saver

Font size — to set the font size for messaging, contacts, and web pages

Operator logo — to display the operator logo

Cell info display — to display the cell identity, if available from the network

My shortcuts

With personal shortcuts, you get quick access to frequently used functions of your phone.

Left and right selection keys

To change the function assigned to the left or right selection key, select **Menu > Settings > My shortcuts > Left selection key** or **Right selection key**, and the desired function.

In the home screen mode, if the left selection key is **Go to**, to activate a function, select **Go to > Options** and from the following:

Select options — to add or remove a function

Organize — to rearrange the functions

Other shortcuts

Select **Menu > Settings > My shortcuts** and from the following:

Navigation key — to assign other functions from a predefined list to the navigation key (scroll key)

Home screen key — to select the movement of the navigation key to activate the home screen mode

Assign dialing shortcuts

Create shortcuts by assigning phone numbers to the number keys 2-9.

- 1 Select **Menu > Contacts > 1-touch dialing**, and scroll to a number key.
- 2 Select **Assign**, or, if a number has already been assigned to the key, select **Options > Change**.
- 3 Enter a number or search for a contact.

Voice commands

You can use voice commands to make phone calls, launch applications, and activate profiles. Voice commands are language-dependent.

Select **Menu > Settings and Phone**.



Set the language

Select **Language settings > Phone language** and the language.

Train voice recognition to your voice

Select **Voice recognition > Voice recog. training**.

Activate a voice command for a function

Select **Voice recognition** > **Voice commands**, a feature, and the function.  indicates that the voice command is activated. If  is not displayed, select **Add**.

Play an activated voice command

Select **Play**.

Rename or deactivate a voice command

Scroll to a function, and select **Options** > **Edit** or **Remove**.

Activate or deactivate all voice commands

Select **Options** > **Add all** or **Remove all**.

Connect

Your phone provides several features to connect to other devices to transmit and receive data.

Bluetooth wireless technology

Bluetooth technology allows you to connect your device, using radio waves, to a compatible Bluetooth device within 10 metres (32 feet).

This device is compliant with Bluetooth Specification 2.1 + EDR supporting the following profiles: SIM access, phonebook access, object push, file transfer, headset, handsfree, generic access, serial port, generic object exchange, advanced audio distribution, audio video remote control, service discovery application, personal area networking, and generic audio/video distribution. To ensure interoperability between other devices supporting Bluetooth technology, use Nokia approved accessories for this model. Check with the manufacturers of other devices to determine their compatibility with this device.

Features using Bluetooth technology increase the demand on battery power and reduce the battery life.

When the wireless device is in the remote SIM mode, you can only use a compatible connected accessory, such as a car kit, to make or receive calls.

Your wireless device will not make any calls, except to the emergency numbers programed into your device, while in this mode.

To make calls, you must first leave the remote SIM mode. If the device has been locked, enter the lock code to unlock it first.

Open a Bluetooth connection

- 1 Select **Menu > Settings > Connectivity > Bluetooth**.
- 2 Select **My phone's name**, and enter a name for your device.
- 3 To activate Bluetooth connectivity, select **Bluetooth > On**.  indicates that Bluetooth connectivity is active.
- 4 To connect your device to an audio accessory, select **Conn. audio access.** and the accessory.
- 5 To pair your device with any Bluetooth device in range, select **Paired devices > Add new device**.
- 6 Scroll to a found device, and select **Add**.
- 7 Enter a passcode (up to 16 characters) on your device, and allow the connection on the other Bluetooth device.

Operating the device in hidden mode is a safer way to avoid malicious software. Do not accept Bluetooth connectivity from sources you do not trust. Alternatively, switch off the Bluetooth function. This does not affect other functions of the device.

Connect your PC to the internet

You can use Bluetooth technology to connect your compatible PC to the internet. Your device must be able to connect to the internet (network service), and your PC must support Bluetooth technology. After connecting to the network access point (NAP) service of the device and pairing with your PC, your device automatically opens a GPRS connection to the internet.

Packet data

General packet radio service (GPRS) is a network service that allows cellular phones to send and receive data over an internet protocol (IP) based network.

To define how to use the service, select **Menu > Settings > Connectivity > Packet data > Packet data conn.** and from the following:

When needed — Establish a packet data connection when needed by an application. The connection is closed when the application is closed.

Always online — Automatically connect to a packet data network when you switch the device on.

You can use your device as a modem by connecting it to a compatible PC using Bluetooth technology. For details, see the Nokia Ovi Suite documentation.

USB data cable

You can use the USB data cable to transfer data between the phone and a compatible PC or a printer supporting PictBridge.

To activate the phone for data transfer or image printing, connect the data cable and select the mode:

PC Suite — to use the USB data cable for Nokia Ovi Suite or Nokia PC Suite

Printing & media — to use the phone with a PictBridge compatible printer or with a compatible PC

Data storage — to connect to a PC that does not have Nokia software and use the phone as data storage

To change the USB mode, select **Menu > Settings > Connectivity > USB data cable** and the desired USB mode.

Synchronization and backup

Select **Menu > Settings > Sync and backup** and from the following:

Synchronization — Create a backup of your personal data to a Nokia server. Before you start a backup, you need to set up your My Nokia account. Select **Connect**, and you will be guided through the process.

Phone switch — Synchronize or copy selected data between your device and another device using Bluetooth technology.

Create backup — Create a backup of selected data.

Restore backup — Select a stored backup file, and restore it to the device. Select **Options > Details** for information about the selected backup file.

Data transfer — Synchronize or copy selected data between your device and another device, PC, or network server (network service).

Connect a USB device

You can connect a USB storage (for example, a memory stick) to your device and browse in the file system and transfer files.

- 1 Connect a compatible adapter cable to the USB port of your device.
- 2 Connect the USB storage to the adapter cable.
- 3 Select **Menu > Gallery** and the USB device to browse.

Note: Not all USB storage devices are supported, depending on their power consumption.

Install Nokia Ovi Suite on your PC

You can manage content on your device, and keep it in sync with your computer. You can also update your device with the latest software, and download maps.

- 1 Use a compatible USB data cable to connect your device to your computer. Your memory card appears as a removable disk on your PC.

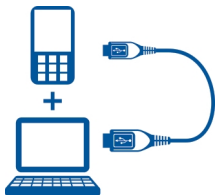

- 2 On your device, select **Data storage**.
- 3 On your computer, select **Install Nokia Ovi Suite**.



If the installation window does not open automatically, open the installation file manually. Select **Open folder to view files**, and double-click **Install_Nokia_Ovi_Suite.exe**.



- 4 Follow the instructions.

To learn more about Nokia Ovi Suite, go to www.ovi.com.

Network provider services

Your network provider provides several additional services you may want to use. For some of these services, charges may apply.

Operator menu

Access a portal to services provided by your network operator. For more information, contact your network operator. The operator can update this menu with a service message.

SIM services

Your SIM card may provide additional services. You can access this menu only if it is supported by your SIM card. The name and contents of the menu depend on the available services.

Accessing these services may involve sending messages or making a phone call for which you may be charged.

Position log

The network may send you a position request (network service). To subscribe and agree upon the delivery of positioning information, contact your service provider.

To accept or reject the position request, select **Accept** or **Reject**. If you miss the request, the phone automatically accepts or rejects it according to what you have agreed with your network operator or service provider.

To view the information on the 10 most recent privacy notifications and requests, select **Menu > Log > Positioning > Position log**.

Info messages, SIM messages, and service commands

Info messages

You can receive messages on various topics from your service provider (network service). For more information, contact your service provider.

Select **Menu > Messaging > Info messages** and from the available options.

Service commands

Service commands allow you to write and send service requests (USSD commands) to your service provider, such as activation commands for network services.

To write and send the service request, select **Menu > Messaging > Serv. commands**. For details, contact your service provider.

SIM messages

SIM messages are specific text messages that are saved to your SIM card. You can copy or move those messages from the SIM to the phone memory, but not vice versa.

To read SIM messages, select **Menu > Messaging > Options > SIM messages**.

Configuration settings

You can configure your device with settings that are required for certain services. You may receive these settings as a configuration message from your service provider.

Select **Menu > Settings**.

Select **Configuration** and from the following:

Default config. sett. — View the service providers saved in the device, and set a default service provider.

Act. def. in all apps. — Activate the default configuration settings for supported applications.

Preferred access pt. — View the saved access points.

Device manager sett. — Allow or prevent the device from receiving software updates. This option may not be available, depending on your device.

Personal config. sett. — Add manually new personal accounts for various services, and activate or delete them. To add a new personal account, select **Add new** or **Options > Add new**. Select the service type, and enter the required parameters.

To activate a personal account, scroll to the account, and select **Options > Activate**.

Stay in touch

Learn how to make calls, write text, send messages, and use the e-mail functionality of your device.

Make calls

Make a voice call

Dial a number manually

Enter the phone number, including the area code, and press the call key.

For international calls, press * twice for the international prefix (the + character replaces the international access code), enter the country code, the area code without the leading 0, if necessary, and the phone number.

The + character as replacement for the international access code may not work in all regions. In this case, enter the international access code directly.

Redial a number

To access the list of dialed numbers, in the standby mode, press the call key. Select a number or name, and press the call key.

Call a contact.

Select **Menu > Contacts and Names**. Select a contact, and press the call key.

Handle voice calls

To handle calls with the slide, select **Menu > Settings > Call > Slide call handling**.

Answer an incoming call

Press the call key, or open the slide.

End a call

Press the end key, or close the slide.

Mute the ringing tone

Select **Silence**.

Reject an incoming call

Press the end key.

Adjust the volume of a call

Use the volume keys.

Dialing shortcuts

To assign a phone number to one of the number keys, select [See "Assign dialing shortcuts," p. 29.](#)

Use a dialing shortcut to make a call in one of the following ways:

- Press a number key, then the call key.
- If **Menu > Settings > Call > 1-touch dialing > On** is selected, press and hold a number key.

Voice dialing

Make a phone call by saying the name that is saved in Contacts.

As voice commands are language-dependent, before voice dialing you must select **Menu > Settings > Phone > Language settings > Phone language** and your language.

Note: Using voice tags may be difficult in a noisy environment or during an emergency, so you should not rely solely upon voice dialing in all circumstances.

- 1 In the home screen mode, press and hold the right selection key. A short tone sounds, and **Speak after the tone** is displayed.
- 2 Say the name of the contact you want to dial. If the voice recognition is successful, a list of proposed matches is displayed. The phone plays the voice command of the first match on the list. If it is not the correct command, scroll to another entry.

Options during a call

Many of the options that you can use during a voice call are network services. For availability, contact your service provider.

During a call, select **Options** and from the available options.

Some of the network options are **Hold**, **New call**, **Add to conference**, **End all calls**, and the following:

Touch tones — to send tone strings

Swap — to switch between the active call and the call on hold

Transfer calls — to connect a call on hold to an active call and disconnect yourself

Conference — to make a conference call

Private call — to have a private discussion in a conference call

Voice messages

The voice mailbox is a network service to which you may need to subscribe. For more information, contact your service provider.

Call your voice mailbox

Press and hold **1**.

Edit your voice mailbox number

Select **Menu** > **Messaging** > **Voice messages** > **Voice mailbox no..**

Call log

To view the information on your calls, messages, data, and synchronization, select **Menu** > **Log** and the desired item.

Note: The actual invoice for calls and services from your service provider may vary, depending on network features, rounding off for billing, taxes, and so forth.

Call settings

Select **Menu** > **Settings** and **Call** and from the following:

Call forwarding — Divert your incoming calls (network service). You may not be able to divert your calls if some call barring functions are active.

Anykey answer — Answer an incoming call by briefly pressing any key, except the power key, the left and right selection keys, or the end key.

Automatic redial — The device redials the number automatically if a call fails. The device tries to call the number 10 times.

Voice clarity — Improve speech intelligibility, especially in noisy environments.

1-touch dialing — Dial the names and phone numbers assigned to the number keys (2-9) by pressing and holding the corresponding number key.

Call waiting — The network notifies you of an incoming call while you have a call in progress (network service).

Call duration display — Display the duration of the call in progress.

Summary after call — Briefly display the approximate duration after each call.

Send my caller ID — Show your phone number to the person you are calling (network service). To use the setting agreed upon with your service provider, select **Set by network**.

Outgoing call line — Select the phone line for making calls, if your SIM card supports multiple phone lines (network service).

Slide call handling — Answer or end a call by opening or closing the slide.



Text and messages

Write text, and create messages and notes.

Write text

Text modes

To enter text (for example, when writing messages) you can use traditional or predictive text input.

When you write text, press and hold **Options** to switch between traditional text input, indicated by , and predictive text input, indicated by . Not all languages are supported by predictive text input.

The character cases are indicated by **AbC**, **abC**, and **ABC**.

To change the character case, press **#**. To change from the letter to number mode, indicated by **123**, press and hold **#**, and select **Number mode**. To change from the number to the letter mode, press and hold **#**.

To set the writing language, select **Options** > **Writing language**.

Traditional text input

Press a number key, 2-9, repeatedly until the desired character appears. The available characters depend on the selected writing language.

If the next letter you want is located on the same key as the present one, wait until the cursor appears, and enter the letter.

To access the most common punctuation marks and special characters, press **1** repeatedly. To access the list of special characters, press *****. To insert a space, press **0**.

Predictive text input

Predictive text input is based on a built-in dictionary to which you can also add new words.

- 1 Start writing a word, using the keys **2** to **9**. Press each key only once for one letter.
- 2 To confirm a word, scroll right or add a space.
 - If the word is not correct, press ***** repeatedly, and select the word from the list.
 - If the **?** character is displayed after the word, the word you intended to write is not in the dictionary. To add the word to the dictionary, select **Spell**. Enter the word using traditional text input, and select **Save**.
 - To write compound words, enter the first part of the word, and scroll right to confirm it. Write the last part of the word, and confirm the word.
- 3 Start writing the next word.

Text and multimedia messages

You can create a message and optionally attach, for example, a picture. Your phone automatically changes a text message to a multimedia message when a file is attached.

Text messages

Your device supports text messages beyond the limit for a single message. Longer messages are sent as two or more messages. Your service provider may charge accordingly. Characters with accents, other marks, or some language options take more space, and limit the number of characters that can be sent in a single message.

The total number of characters left and the number of messages needed for sending are displayed.

To send messages, the correct message centre number must be stored in your device. Normally, this number is set by default through your SIM card. To set the

number manually, select **Menu > Messaging > Message settings > Text messages > Message centers > Add center**, and enter a name and the number from the service provider.

Multimedia messages

A multimedia message can contain text, pictures, and sound or video clips.

Only devices that have compatible features can receive and display multimedia messages. The appearance of a message may vary depending on the receiving device.

The wireless network may limit the size of MMS messages. If the inserted picture exceeds this limit, the device may make it smaller so that it can be sent by MMS.

Important: Exercise caution when opening messages. Messages may contain malicious software or otherwise be harmful to your device or PC.

For availability and subscription to the multimedia messaging service (MMS), contact your service provider.

Create a text or multimedia message

- 1 Select **Menu > Messaging > Create message > Message**.
- 2 To add recipients, scroll to the **To:** field, and enter the recipient's number or e-mail address, or select **Add** to select recipients from the available options. Select **Options** to add recipients and subjects and to set sending options.
- 3 Scroll to the **Text:** field, and enter the message text.
- 4 To attach content to the message, scroll to the attachment bar at the bottom of the display, and select the desired type of content.
- 5 To send the message, select **Send**.

The message type is indicated at the top of the display and changes automatically depending on the content of the message.

Service providers may charge differently depending on the message type. For details, contact your service provider.

Conversations and Inbox view

In **Conversations**, you can view your received messages together with related messages and replies you have sent. You can switch to the traditional **Inbox** view to list your received messages one by one.

Select **Menu** > **Messaging**.

View messages in a conversation

- 1 Select **Conversations**.
- 2 Scroll to a conversation and select **Open**.
- 3 Scroll to a message and select **Options** > **Open**.

Switch between Conversations and Inbox views

Select **Options** > **Inbox view** or **Conversation view**.

Read a message and reply

Your device notifies you when you receive a message.

Important: Exercise caution when opening messages. Messages may contain malicious software or otherwise be harmful to your device or PC.

Read the received message

Select **View**. If more than one message was received, select the message from **Inbox** or **Conversations**.

Reply to the message

Select **Reply**.

Send and organize messages

To send a message, select **Send**. The phone saves the message in the Outbox folder, and the sending starts.

Note: The message sent icon or text on your device screen does not indicate that the message is received at the intended destination.

If message sending is interrupted, the phone tries to resend the message a few times. If these attempts fail, the message remains in the Outbox folder. To cancel message sending, in the Outbox folder, select **Options > Cancel sending**.

To save the sent messages in the Sent items folder, select **Menu > Messaging > Message settings > General settings > Save sent messages**.

The phone saves received messages in the Inbox folder. Organize your messages in the Saved items folder.

To add, rename, or delete a folder, select **Menu > Messaging > Saved items > Options**.

Flash messages

Flash messages are text messages that are instantly displayed upon reception.

- 1 To write a flash message, select **Menu > Messaging > Create message > Flash message**.
- 2 Enter the recipient's phone number, write your message (maximum 70 characters), and select **Send**.

Nokia Xpress audio messages

Create and send an audio message using MMS in a convenient way.

- 1 Select **Menu > Messaging > Create message > Audio message**. The voice recorder opens.
- 2 Record your message.

- 3 Enter one or more phone numbers in the **To:** field, or select **Add** to retrieve a number.
- 4 To send the message, select **Send**.

Message settings

Select **Menu** > **Messaging** > **Message settings** and from the following:

General settings — Save copies of sent messages in your device, overwrite old messages if the message memory becomes full, and set up other preferences related to messages.

Text messages — Allow delivery reports, set up message centres for SMS and SMS e-mail, select the type of character support, and set up other preferences related to text messages.

Multimedia messages — Allow delivery reports, set up the appearance of multimedia messages, allow the reception of multimedia messages and advertisements, and set up other preferences related to multimedia messages.

Service messages — Activate service messages, and set up preferences related to service messages.

Mail and Instant Messaging

Set up your device to send and receive mails from your mail account or to chat in your instant messaging (IM) community.

Nokia Messaging IM

With instant messaging (IM) you can chat with other online users using your device.

You can use your already existing account with an IM community that is supported by your device.

If you are not registered to a IM service, you can create an IM account with a supported IM service, using your computer or your device. The menus may vary depending on the IM service.

IM services

Sign in to an existing IM account

- 1 Select **Menu** > **Messaging** > **Instant messaging**.
- 2 Select an IM service.
- 3 Enter your account ID and password.
- 4 Follow the instructions on the display.

Create a new Nokia account

To create a Nokia account, which includes mail and IM services, using your PC, visit www.ovi.com. To create an account using your device, do the following:

- 1 Select **Menu** > **Messaging** > **E-mail message**.
- 2 Follow the instructions on the display.

Use IM services simultaneously

- 1 To return to the IM main view, select **Home** from within any IM service.
- 2 Select an IM service, and sign in.
- 3 To switch between IM services, in the contacts list view, scroll left or right.

Exchange messages

Select **Menu** > **Messaging** > **Instant messaging**.

Send an IM

- 1 Select an IM service.
- 2 Select a contact from the contacts list.
Each conversation is on a tab in the conversation view.
- 3 Enter your message in the text box at the bottom of the display.
- 4 Select **Send**.

Receiving messages

When a new message arrives in your current conversation, the message appears at the end of the chat history. When a new message arrives for another conversation, the corresponding conversation tab flashes. To switch between conversations, do the following:

- 1 Scroll up to the conversation tabs.
- 2 Scroll left or right to open a conversation.

When a new message arrives from another community, it is indicated at the top or bottom corner.

Scroll up, and select **Switch** or **Select**.

Notification settings

Even when you are not using the application, you are notified of new messages. To modify notification settings, do the following:

- 1 In the IM main view, select **Options** > **IM settings**.
- 2 Select a notification type and **Save**.

Leave the IM application

When you exit the Instant messaging (IM) application, you remain signed in to IM services. Your sessions remain active for a period of time, according to your service subscription. When the IM application is running in the background, you can open other applications, and return to using IM without signing in again.

Close the IM window

Go to the IM main view, and select **Exit**.

Sign out from IM

Select **Options** > **Sign Out**.

All conversations are closed.

Nokia Messaging Mail

Access your mail accounts from different providers with your mobile device to read, write, and send mail.

Before you can use mail, you must have an mail account. If you do not have already an mail account, create it in Ovi. The menus may vary depending on the mail provider.

Set up mail

You can sign in to an existing mail account or set up a new Ovi Mail account.

Select **Menu > Messaging > E-mail message.**

Sign in to your mail account

- 1 Select your mail service provider.
- 2 Enter your account ID and password.
- 3 Select **Remember password** to disable the password query when you access your mail account.
- 4 Select **Sign In.**

To sign in to an additional mail account, select **Add account.**

Set up Ovi Mail

If you do not already have a mail account, you can create a Nokia account, which includes the Ovi Mail service.

- 1 Select **Get Ovi Mail.**
- 2 Follow the instructions on the display.

Once you have created your new Nokia account, you can sign in to the Ovi Mail service and start sending and receiving mail. You can also use the account to sign into other Ovi services, such as IM. For more information, see www.ovi.com.

Read, create, and send mail

Select **Menu** > **Messaging** > **E-mail message** and a mail account.

Read mail and reply

- 1 Select a mail and **Open**.
- 2 Use the scroll key to see the entire mail.
- 3 To reply to or forward mail, select **Options**.

View and save attachments

Mail with attachments, for example, pictures, are marked with a paperclip icon. Some attachments may not be compatible with your device, and cannot be displayed on your device.

- 1 Expand the attachments list.
- 2 Select an attachment and **View**.
- 3 To save the attachment to your device, select **Save**.

Create and send mail

- 1 Select **Options** > **Compose**.
- 2 Enter the recipient's mail address, the subject, and your message.
- 3 To attach a file to the mail, select **Options** > **Attach file**.
- 4 To capture an image to attach to the mail, select **Options** > **Attach new image**.
- 5 To send the mail, select **Send**.

Close the mail application

Select **Sign Out**.

Access IM from your mail account

Some mail service providers allow you to access your instant messaging account directly from your mail account.

To sign in to your provider's instant messaging service when writing a mail, select **Options** and your IM service.

Image and video

Capture images

Activate the camera

Press the capture key; or, if in video mode, scroll left or right.

Zoom in or out.

In image mode, scroll up and down, or use the volume keys.

Capture an image

Press the capture key.

Images are saved in Gallery.

Display images after capture

Select **Options** > **Settings** > **Photo preview time** and the preview time.

End the image preview manually

Select **Back**.

Your device supports an image capture resolution of up to 1536x2048 pixels.

Record videos

Activate video mode

Press and hold the capture key, or, if in image mode, scroll left or right.

Start recording

Press the capture key.

Pause or resume recording

Select **Pause** or **Continue**.

Alternatively, press the capture key.

Stop recording

Select **Stop**.

Videos are automatically saved in Gallery.

Camera and video settings

Select **Menu** > **Media** > **Camera**.

In image or video mode, select **Options** and from the following:

Self-timer — Use the self-timer.

Effects — Apply different effects (for example, greyscale and false color) to the captured image.

White balance — Adapt the camera to the current light conditions.

Landscape format or **Portrait photo** — Select the orientation of the camera.

Settings — Modify other camera and video settings, and select where to save images and videos.

Gallery

Manage images, videos, music files, themes, graphics, tones, recordings, and received files. These files are stored in the device memory or on a memory card and may be arranged in folders.

Photos

View images and play videos with the Photos application.

Select **Menu** > **Gallery** > **Photos**.

Select from the following:

All photos — View images in a thumbnail grid. You can sort images by date, name, or size.

Timeline — View images in the order they were captured.

Albums — Sort images into albums. You can create, rename and remove albums. If you remove an album, the images inside the album are not deleted from the memory.

Rotate an image

Select **Options** > **Landscape mode** or **Portrait mode**.

View a slide show

A slide show uses the images of the currently selected folder or album.

- 1 Select **All photos**, **Timeline** or **Albums**.
- 2 Select **Options** > **Slide show**.
- 3 Select **Start slide show**.

Edit images

You can, for example, rotate, flip, crop, and adjust the brightness, contrast, and colors of images.

54 Image and video

- 1 Select an image in All photos, Timeline, or Albums.
- 2 Select **Options** > **Edit photo**.
- 3 Select an editing option, and use the scroll key to change the settings or values.

Music and videos

Your device includes a media player for playing songs and videos. Music and video files stored in the music folder in the device memory or on the memory card are automatically detected and added to the video or music library.

Select **Menu** > **Gallery** and **Music & videos**.

Select from the following:

Videos — List all available videos.

All songs — List all available songs. You can sort songs by artist, album, or genre, for example.

Manage folders and files

To manage folders and files in Gallery, select **Menu** > **Gallery**.

View a list of folders

Select **All content**.

View a list of files in a folder

Select a folder and **Open**.

View the folders of the memory card when moving a file

Scroll to the memory card, and scroll right.

Print images

Your device supports Nokia XpressPrint, allowing you to print images in the JPEG file format.

- 1 Connect your device to a compatible printer, using a USB data cable, or, if supported by the printer, Bluetooth connectivity.
- 2 Select an image from Gallery and **Options** > **Print**.

Memory card

Use a memory card to store your multimedia files, such as videos, songs, sound files, images, and messaging data.

Select **Menu** > **Gallery** > **All content** > **Memory card**.

Some of the folders in Gallery that contain content used by your device (for example, Themes) can be stored on the memory card.

If your memory card has not been pre-formatted, you need to format it. When you format a memory card, all data on the card is permanently deleted.

Format the memory card

Select **Options** > **Mem. card options** > **Format memory card** > **Yes**. When formatting is complete, enter a name for the memory card.

Protect the memory card with a password

Select **Options** > **Mem. card options** > **Set password**. The password is stored in your device, so you only have to enter the password when attempting to use the memory card in another device.

Remove the memory card password

Select **Options** > **Mem. card options** > **Delete password**.

Check the memory consumption

Select **Options** > **Details**. The memory consumption of different data groups, and the amount of available memory to install new software, is displayed.

Entertainment

Listen to music

Listen to music with the music player or radio, and record sounds or voice with the voice recorder. Download music from the internet, or transfer music from your PC.

Warning:

Continuous exposure to high volume may damage your hearing. Listen to music at a moderate level, and do not hold the device near your ear when the loudspeaker is in use.

Media Player

To open the media player, select **Menu > Media > Media player**.

Music menu

Access your music and video files stored in the device memory or on the memory card, download music or videos from the web, or view compatible video streams from a network server (network service).

Select **Menu > Media > Media player**.

Play a media file

Select a file from the available folders and **Play**.

Download files from the web

Select **Options > Downloads** and a download site.

Update the music library after adding files

Select **Options > Update library**.

Create a playlist

- 1 Select **Playlists** > **Create playlist**, and enter the name of the playlist.
- 2 Add music or videos from the displayed lists.
- 3 To store the playlist, select **Done**.

Configure a streaming service

You may receive the streaming settings as a configuration message from the service provider. You can also enter the settings manually.

- 1 Select **Options** > **Downloads** > **Streaming settings** > **Configuration**.
- 2 Select a service provider, **Default**, or **Personal config**. for streaming.
- 3 Select **Account** and a streaming service account from the active configuration settings.

Play songs

Operate the media player

Press the music keys, or use the scroll keys according to the virtual keys on the display.

Adjust the volume.

Use the volume keys.

Start or pause playing

Press .

Skip to the next song

Press .

Skip to the previous song

Press  twice.

Fast-forward the current song

Press and hold .

Rewind the current song

Press and hold .

Switch to the music menu

Select .

Switch to the current playlist

Select .

Leave the media player playing in the background

Press the end key.

Stop the media player

Press and hold the end key.

Change the media player look

Your device provides several themes to change the look of the media player.

Select **Menu > Media > Media player** and **Go to Media player > Options > Settings > Media player theme** and the desired theme.

The virtual keys may change depending on the theme.

Transfer music from a computer

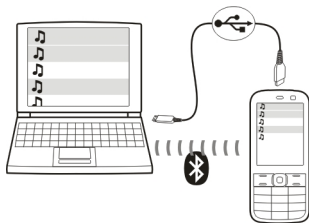

You can transfer music to your device in the following ways:

- Use Nokia Music to transfer, rip, burn, and play new music on your PC and mobile device. Download the PC software from www.music.nokia.com/download.
- Use Nokia Ovi Suite to connect your device to your PC using Bluetooth connectivity or a compatible USB data cable, and use the Nokia Music Manager. To use a USB data cable, select **PC Suite** as the connection mode.
- Connect your device to your PC using Bluetooth connectivity or a compatible USB data cable, and copy music files to the device memory. To use a USB data cable, select **Data storage** as the connection mode.
- Use Windows Media Player. Connect a compatible USB data cable, and select **Printing & media** as the connection mode.

Radio



Select **Menu > Radio**.

Your device supports Nokia XpressRadio, allowing you to listen to radio stations with the built-in FM antenna. To improve reception, connect a compatible headset, to use as an external FM antenna. To activate the loudspeaker, select **Menu > Radio and Options > Settings > Play via > Loudspeaker**.



It is not possible to listen to the radio through a Bluetooth headset.

Tune in to radio stations

Operate the radio

Use the scroll key according to the virtual keys on the display.
Alternatively, use the music keys , , and .

Search for the next available station

Press and hold the scroll key left or right.
Alternatively, press and hold the  or  music key.

Tune the radio frequency in 0.05 MHz steps

Briefly press the scroll key left or right.



Save a station to a memory location

Select **Options** > **Save station**.

Enter the name of a radio station

Select **Options** > **Stations** > **Options** > **Rename**.

Switch to another saved station

Scroll up or down.
Alternatively, press the  or  music key.
To access a station directly from the saved station list, press the number key that corresponds to the number of the station.

Adjust the volume.

Use the volume keys.

Pause or resume playback

Press the scroll key ( / .

Alternatively, press the >|| music key.

Set the radio to play in the background

Briefly press the end key.

Close the radio

Press and hold the end key.

Select **Options** and from the following:

Search all stations — Search automatically for the available stations at your location. For best results, search when outdoors or near a window.

Set frequency — Enter the frequency of a radio station.

Station directory — Access a website with a list of radio stations (network service).

Stations — List, rename, or delete saved stations.

Radio settings

Select **Menu** > **Radio**.

Select **Options** > **Settings** and from the following:

RDS — Display information from the radio data system, such as the name of the station.

Auto-frequency — Allow the device to automatically switch to a frequency with better reception (available when RDS is activated).

Play via — Listen using the headset or the loudspeaker.

Output — Switch between stereo and mono output.

Radio theme — Select the look of the radio.

Voice recorder

Record speech, sound, or an active call, and save the recordings in Gallery.

Select **Menu** > **Media** > **Voice recorder**.

The recorder cannot be used when a data call or GPRS connection is active.

To use the graphical keys , , or , scroll left or right.

Start recording

Select , or, during a call, select **Options** > **Record**. While recording a call, all parties to the call hear a faint beeping.

Pause recording

Select .

Stop recording

Select . The recording is saved in the Recordings folder in Gallery.

To play or send the last recording, to access the list of recordings, or to select the memory and the folder to store the recordings, select **Options** and the appropriate option.

Equalizer

Adjust the sound when using the media player.

Select **Menu** > **Media** > **Equalizer**.

Activate a predefined equalizer set

Scroll to a set, and select **Activate**.

Create a new equalizer set

- 1 Select one of the last two sets in the list and **Options** > **Edit**.
- 2 Use the scroll key to adjust the sound controls.

- 3 To save the settings and enter a name for the set, select **Save and Options > Rename**.

Stereo widening

Stereo widening creates a wider stereo sound effect when you are using a stereo headset.

Select **Menu > Media and Stereo widening**.

Web

You can access various internet services with your device browser (network service). The appearance of the internet pages may vary due to screen size. You may not be able to see all the details on the internet pages.

Important: Use only services that you trust and that offer adequate security and protection against harmful software.

For the availability of these services, pricing, and instructions, contact your service provider.

You may receive the configuration settings required for browsing as a configuration message from your service provider.

To set up the service, select **Menu > Internet > Web settings > Configuration sett.**, a configuration, and an account.

Connect to a service

To make a connection to the service, select **Menu > Internet > Home**; or in the standby mode, press and hold **0**.

To select a bookmark, select **Menu > Internet > Bookmarks**.

To select the last visited URL, select **Menu > Internet > Last web addr.**

To enter the address of a service, select **Menu > Internet > Go to address**. Enter the address, and select **OK**.

After you make a connection to the service, you can start browsing its pages. The function of the phone keys may vary in different services. Follow the text guides on the phone display. For more information, contact your service provider.

Web uploads

Open the web page of your online sharing service to view uploaded images and videos and to change settings (network service).

Open an online sharing service

- 1 Select **Menu > Internet > Web uploads** and an online sharing service.
- 2 Select from the links offered by the service.

Change settings of an online sharing service

- 1 Select **Menu > Internet > Web uploads** and an online sharing service.
- 2 Select **Options > Settings** to open the settings page of the service.

Appearance settings

While browsing the web, select **Options > Settings** and from the following:

Display — Select the font size, whether images are shown, and how the text is displayed.

General — Select whether web addresses are sent as Unicode (UTF-8), the encoding type for the contents, and whether JavaScript™ is enabled.

The available options may vary.

Cache memory

A cache is a memory location that is used to store data temporarily. If you have tried to access or have accessed confidential information requiring passwords, empty the

cache after each use. The information or services you have accessed are stored in the cache.

A cookie is data that a site saves in the cache memory of your phone. Cookies are saved until you clear the cache memory.

To clear the cache while browsing, select **Options** > **Tools** > **Clear the cache**.

To allow or prevent the phone from receiving cookies, select **Menu** > **Internet** > **Web settings** > **Security** > **Cookies**; or, while browsing, select **Options** > **Settings** > **Security** > **Cookies**.

Browser security

Security features may be required for some services, such as banking services or online shopping. For such connections you need security certificates and possibly a security module, which may be available on your SIM card. For more information, contact your service provider.

To view or change the security module settings, or to view a list of authority or user certificates downloaded to your device, select **Menu** > **Settings** > **Security** > **Security module sett.**, **Authority certificates**, or **User certificates**.

Important: Even if the use of certificates makes the risks involved in remote connections and software installation considerably smaller, they must be used correctly in order to benefit from increased security. The existence of a certificate does not offer any protection by itself; the certificate manager must contain correct, authentic, or trusted certificates for increased security to be available. Certificates have a restricted lifetime. If "Expired certificate" or "Certificate not valid yet" is shown, even if the certificate should be valid, check that the current date and time in your device are correct.

Before changing any certificate settings, you must make sure that you really trust the owner of the certificate and that the certificate really belongs to the listed owner.

Games and applications

You can manage applications and games. Your phone may have some games or applications installed. These files are stored in the phone memory or an attached memory card and may be arranged in folders.

Launch an application

Select **Menu > Applications > Games, Memory card, or Collection**. Scroll to a game or an application, and select **Open**.

To set sounds, lights, and shakes for a game, select **Menu > Applications > Options > Application settings**.

Other available options may include the following:

Update version — to verify that a new version of the application is available for download from the web (network service)

Web page — to provide further information or additional data for the application from an internet page (network service), if available

Application access — to restrict the application from accessing the network

Download an application

Your phone supports J2ME™ Java applications. Ensure that the application is compatible with your phone before downloading it.

Important: Only install and use applications and other software from trusted sources, such as applications that are Symbian Signed or have passed the Java Verified™ testing.

You can download new applications and games in different ways.

- Select **Menu > Applications > Options > Downloads > App. downloads or Game downloads**; the list of available bookmarks is shown.
- Use Nokia Ovi Suite to download the applications to your phone.

For the availability of different services and pricing, contact your service provider.

Maps

You can browse maps for different cities and countries, search for addresses and points of interest, plan routes from one location to another, save locations as landmarks, and send them to compatible devices.

Almost all digital cartography is inaccurate and incomplete to some extent. Never rely solely on the cartography that you download for use in this device.

Note: Downloading content such as maps, satellite images, voice files, guides or traffic information may involve transmission of large amounts of data (network service).

Content such as satellite images, guides, weather and traffic information and related services are generated by third parties independent of Nokia. The content may be inaccurate and incomplete to some extent and is subject to availability. Never rely solely on the aforementioned content and related services.

Find detailed information about Maps on www.nokia.com/maps.

To use the Maps application, select **Menu > Organizer > Maps** and from the available options.

Download maps

Your device may contain pre-installed maps on the memory card. You can download a new set of maps through the internet using the Nokia Map Loader PC software.

Download and install Nokia Map Loader

- 1 To download the Nokia Map Loader on your PC and for further instructions, visit www.maps.nokia.com.
- 2 Select **Menu > Organizer > Maps** to do an initial configuration.

Download maps

Before you download new maps for the first time, ensure that you have a memory card inserted in the device.

To change the selection of maps on your memory card, use the Nokia Map Loader to delete all maps on the memory card and download a new selection, to ensure that all maps are from the same release.

Download maps automatically

Select **Menu > Organizer > Maps and Settings > Network settings > Allow network usage > Yes** or **In home network**.

Deactivate automatic download

Select **No**.

Note: Downloading content such as maps, satellite images, voice files, guides or traffic information may involve transmission of large amounts of data (network service).

Maps and GPS

Your device does not have an internal GPS antenna. To use applications that require a GPS connection, use a compatible external GPS receiver (accessory sold separately). Pair the GPS receiver with your device using Bluetooth wireless technology. For more information, see the user guide of the GPS receiver.

You can use the Global Positioning System (GPS) to support the Maps application. Find out your location, or measure distances and plot coordinates.

After pairing your device with an external GPS receiver, it may take several minutes for the device to display the current location.

The Global Positioning System (GPS) is operated by the government of the United States, which is solely responsible for its accuracy and maintenance. The accuracy of location data can be affected by adjustments to GPS satellites made by the United

States government and is subject to change with the United States Department of Defense civil GPS policy and the Federal Radionavigation Plan. Accuracy can also be affected by poor satellite geometry. Availability and quality of GPS signals may be affected by your location, buildings, natural obstacles and weather conditions. GPS signals may not be available inside buildings or underground and may be impaired by materials such as concrete and metal.

GPS should not be used for precise location measurement, and you should never rely solely on location data from the GPS receiver and cellular radio networks for positioning or navigation.

Extra services

You can upgrade Maps to a full navigation system to be used by car and by foot. You need a regional license for the full navigation system. The car navigation is fully voice-guided with two- and three-dimensional map views. The pedestrian navigation is limited to a speed of 30 km/h (18.6 miles/h) and provides no voice guidance. The navigation service is not available for all countries and regions. For details, see your local Nokia website.

To use this service, you need a compatible external GPS receiver that supports Bluetooth wireless technology.

Purchase a navigation service

Select **Menu > Organizer > Maps and Extra services > Purchase nav. license**, and follow the instructions.

To use navigation with voice guidance, you must allow the Maps application to use a network connection.

The navigation licence is connected to your SIM card. If you insert another SIM card in your device, you are asked to purchase a licence when starting navigation. During the purchase procedure, you are offered to transfer the existing navigation license to the new SIM card without extra charge.

Organize

Let your phone help you to organize your life.

Manage contacts

Save names, phone numbers, and addresses as contacts in the device and on the SIM card.

Select **Menu > Contacts**.

Select the memory for contacts

The device memory can save contacts with additional details, such as various phone numbers and text items. You can also save an image, a tone, or a video clip for a limited number of contacts.

The SIM card memory can save names with one phone number attached to them. The contacts saved in the SIM card memory are indicated with .

- 1 Select **Settings > Memory in use** to select the SIM card, the device memory, or both for your contacts.
- 2 Select **Phone and SIM** to recall contacts from both memories. When you save contacts, they are saved in the device memory.

Handle contacts

Search for a contact

Select **Menu > Contacts > Names**.

Scroll through the list of contacts, or enter the first characters of the contact's name.

Save a name and phone number

Select **Menu > Contacts > Add new**.

Add or edit a detail

Select a contact and **Details** > **Options** > **Add detail**.

Delete a detail

Select a contact and **Details**. Select a detail and **Options** > **Delete**.

Delete a contact

Select a contact and **Options** > **Delete contact**.

Delete all contacts

Select **Menu** > **Contacts** > **Del. all contacts** > **From phone memory** or **From SIM card**.

Copy or move contacts between the device and SIM card memories**Copy single contacts**

Select **Options** > **Marking options** > **Mark**. Mark the contacts you want to copy or move, and select **Options** > **Copy marked** or **Move marked**.

Copy all contacts

Select **Menu** > **Contacts** > **Copy contacts** or **Move contacts**.

Create a contact group

Arrange contacts into caller groups with different ringing tones and group images.

- 1 Select **Menu** > **Contacts** > **Groups**.
- 2 Select **Add** or **Options** > **Add new group** to create a new group.
- 3 Enter the group name, optionally select an image and a ringing tone, and select **Save**.
- 4 To add contacts to the group, select the group and **View** > **Add**.

Business cards

You can send and receive a person's contact information from a compatible device that supports the vCard standard.

To send a business card, search for the contact, and select **Details** > **Options** > **Send business card**.

When you receive a business card, select **Show** > **Save** to save the business card in the phone memory.

Date and time

To change the clock type, time, time zone, or date, select **Menu** > **Settings** > **Date and time**.

When travelling to a different time zone, select **Menu** > **Settings** > **Date and time** > **Date & time settings** > **Time zone**; and scroll left or right to select the time zone of your location. The time and date are set according to the time zone and enable your phone to display the correct sending time of received text or multimedia messages.

For example, GMT -5 denotes the time zone for New York (USA), 5 hours west of Greenwich, London (UK).

For example, GMT -3 denotes the time zone for Buenos Aires (Argentina), 3 hours west of Greenwich, London (UK).

Alarm clock

To sound an alarm at a desired time.

Set the alarm

- 1 Select **Menu** > **Organizer** > **Alarm clock**.
- 2 Activate the alarm, and enter the alarm time.
- 3 To repeat the alarm on selected days of the week, select **Repeat:** > **On** and the days.

- 4 Select the alarm tone.
- 5 Define the snooze time-out period, and select **Save**.

Stop the alarm

To stop the sounding alarm, select **Stop**.

If you let the alarm sound for a minute or select **Snooze**, the alarm stops for the snooze time-out period, then resumes.

Calendar

Select **Menu > Organizer > Calendar**.

The current day is framed. If there are any notes set for the day, the day is in bold type. To view the day notes, select **View**. To view a week, select **Options > Week view**. To delete all notes in the calendar, select **Options > Delete notes > Delete all notes**.

To edit settings related to date and time, select **Options > Settings** and from the available options. To delete old notes automatically after a specified time, select **Options > Settings > Auto-delete notes** and from the available options.

Make a calendar note

Scroll to the date, and select **Options > Make a note**. Select the note type, and fill in the fields.

To-do list

To create a note for a task that you must do, select **Menu > Organizer > To-do list**.

To create a note if no note is added, select **Add**; otherwise, select **Options > Add**. Fill in the fields, and select **Save**.

To view a note, scroll to it, and select **View**.

Notes

To write and send notes, select **Menu > Organizer > Notes**.

To make a note if no note is added, select **Add**; otherwise, select **Options > Make a note**. Write the note, and select **Save**.

Calculator

Your phone provides a standard, a scientific, and a loan calculator.

Select **Menu > Organizer > Calculator** and, from the available options, the calculator type and the operating instructions.

This calculator has limited accuracy and is designed for simple calculations.

Countdown timer

Normal timer

- 1 To activate the timer, select **Menu > Organizer > Countd. timer > Normal timer**, enter a time, and write a note that is displayed when the time expires. To change the time, select **Change time**.
- 2 To start the timer, select **Start**.
- 3 To stop the timer, select **Stop timer**.

Interval timer

- 1 To have an interval timer with up to 10 intervals started, first enter the intervals.
- 2 Select **Menu > Organizer > Countd. timer > Interval timer**.
- 3 To start the timer, select **Start timer > Start**.

To select how the interval timer should start the next period, select **Menu > Organizer > Countd. timer > Settings > Contin. to next period** and from the available options.

Stopwatch

You can measure time, take intermediate times, or take lap times using the stopwatch.

Select **Menu** > **Organizer** > **Stopwatch** and from the following options:

Split timing — to take intermediate times. To reset the time without saving it, select **Options** > **Reset**.

Lap timing — to take lap times

Continue — to view the timing that you have set in the background

Show last time — to view the most recently measured time if the stopwatch is not reset

View times or **Delete times** — to view or delete the saved times

To set the stopwatch timing in the background, press the end key.

Green tips



Here are tips on how you can contribute to protecting the environment.

Save energy

When you have fully charged the battery and disconnected the charger from the device, unplug the charger from the wall outlet.

You do not need to charge your battery so often if you do the following:

- Close and disable applications, services, and connections when not in use.

76 Product and safety information

- Decrease the brightness of the screen.
- Set the device to enter the power saver mode after the minimum period of inactivity, if available in your device.
- Disable unnecessary sounds, such as keypad and ringing tones.

Recycle

Most of the materials in a Nokia phone are recyclable. Check how to recycle your Nokia products at www.nokia.com/werecycle, or with a mobile device, www.nokia.mobi/werecycle.

Recycle packaging and user guides at your local recycling scheme.

Learn more

For more information on the environmental attributes of your device, see www.nokia.com/ecodeclaration.

Product and safety information

Digital rights management

Content owners may use different types of digital rights management (DRM) technologies to protect their intellectual property, including copyrights. This device uses various types of DRM software to access DRM-protected content. With this device you can access content protected with WMDRM 10, OMA DRM 1.0, OMA DRM 1.0 forward lock, and OMA DRM 2.0. If certain DRM software fails to protect the content, content owners may ask that such DRM software's ability to access new DRM-protected content be revoked. Revocation may also prevent renewal of such DRM-protected content already in your device. Revocation of such DRM software does not affect the use of content protected with other types of DRM or the use of non-DRM-protected content.

Digital rights management (DRM) protected content comes with an associated licence that defines your rights to use the content.

If your device has OMA DRM-protected content, to back up both the licence and the content, use the backup feature of Nokia Ovi Suite.

Other transfer methods may not transfer the licence which need to be restored with the content for you to be able to continue the use of OMA DRM-protected content after the device memory is formatted. You may also need to restore the licence in case the files on your device get corrupted.

If your device has WMDRM-protected content, both the licence and the content will be lost if the device memory is formatted. You may also lose the licence and the content if the files on your device get corrupted. Losing the licence or the content may limit your ability to use the same content on your device again. For more information, contact your service provider.

Some licence may be connected to a specific SIM card, and the protected content can be accessed only if the SIM card is inserted in the device.

Third-party applications

The third-party applications provided with your device may have been created and may be owned by persons or entities not affiliated with or related to Nokia. Nokia does not own the copyrights or intellectual property rights to the third-party applications. As such, Nokia does not take any responsibility for end-user support, functionality of the applications, or the information in the applications or these materials. Nokia does not provide any warranty for the third-party applications.

BY USING THE APPLICATIONS YOU ACKNOWLEDGE THAT THE APPLICATIONS ARE PROVIDED AS IS WITHOUT WARRANTY OF ANY KIND, EXPRESS OR IMPLIED, TO THE MAXIMUM EXTENT PERMITTED BY APPLICABLE LAW. YOU FURTHER ACKNOWLEDGE THAT NEITHER NOKIA NOR ITS AFFILIATES MAKE ANY REPRESENTATIONS OR WARRANTIES, EXPRESS OR IMPLIED, INCLUDING BUT NOT LIMITED TO WARRANTIES OF TITLE, MERCHANTABILITY OR FITNESS FOR A PARTICULAR PURPOSE, OR THAT THE APPLICATIONS WILL NOT INFRINGE ANY THIRD-PARTY PATENTS, COPYRIGHTS, TRADEMARKS, OR OTHER RIGHTS.

Accessories

Warning:

Use only batteries, chargers, and accessories approved by Nokia for use with this particular model. The use of any other types may invalidate any approval or guarantee, and may be dangerous. In particular, use of unapproved chargers or batteries may present a risk of fire, explosion, leakage, or other hazard.

For availability of approved accessories, please check with your dealer. When you disconnect the power cord of any accessory, grasp and pull the plug, not the cord.

Battery

Battery and charger information

Your device is powered by a rechargeable battery. The battery intended for use with this device is BL-4CT. Nokia may make additional battery models available for this device. This device is intended for use when supplied with power from the following chargers: AC-8. The exact charger model number may vary depending on the type of plug. The plug variant is identified by one of the following: E, EB, X, AR, U, A, C, K, or UB.

The battery can be charged and discharged hundreds of times, but it will eventually wear out. When the talk and standby times are noticeably shorter than normal, replace the battery. Use only Nokia approved batteries, and recharge your battery only with Nokia approved chargers designated for this device.

78 Product and safety information

If a battery is being used for the first time or if the battery has not been used for a prolonged period, it may be necessary to connect the charger, then disconnect and reconnect it to begin charging the battery. If the battery is completely discharged, it may take several minutes before the charging indicator appears on the display or before any calls can be made.

Safe removal. Always switch the device off and disconnect the charger before removing the battery.

Proper charging. Unplug the charger from the electrical plug and the device when not in use. Do not leave a fully charged battery connected to a charger, since overcharging may shorten its lifetime. If left unused, a fully charged battery will lose its charge over time.

Avoid extreme temperatures. Always try to keep the battery between 59°F and 77°F (15°C and 25°C). Extreme temperatures reduce the capacity and lifetime of the battery. A device with a hot or cold battery may not work temporarily. Battery performance is particularly limited in temperatures well below freezing.

Do not short-circuit. Accidental short-circuiting can occur when a metallic object such as a coin, clip, or pen causes direct connection of the positive (+) and negative (-) terminals of the battery. (These look like metal strips on the battery.) This might happen, for example, when you carry a spare battery in your pocket or purse. Short-circuiting the terminals may damage the battery or the connecting object.

Disposal. Do not dispose of batteries in a fire as they may explode. Dispose of batteries according to local regulations. Please recycle when possible. Do not dispose as household waste.

Leak. Do not dismantle, cut, open, crush, bend, puncture, or shred cells or batteries. In the event of a battery leak, prevent battery liquid contact with skin or eyes. If this happens, flush the affected areas immediately with water, or seek medical help.

Damage. Do not modify, remanufacture, attempt to insert foreign objects into the battery or immerse or expose it to water or other liquids. Batteries may explode if damaged.

Correct use. Use the battery only for its intended purpose. Improper battery use may result in a fire, explosion, or other hazard. If the device or battery is dropped, especially on a hard surface, and you believe the battery has been damaged, take it to a service center for inspection before continuing to use it. Never use any charger or battery that is damaged. Keep your battery out of the reach of small children.

Nokia battery authentication guidelines

Always use original Nokia batteries for your safety. To check that you are getting an original Nokia battery, purchase it from a Nokia authorized service center or dealer, and inspect the hologram label using the following steps:

Authenticate hologram

- 1 When you look at the hologram on the label, you should see the Nokia connecting hands symbol from one angle and the Nokia Original Accessories logo when looking from another angle.



- 2 When you angle the hologram left, right, down and up, you should see 1, 2, 3 and 4 dots on each side respectively.



Successful completion of the steps is not a total assurance of the authenticity of the battery. If you cannot confirm authenticity or if you have any reason to believe that your Nokia battery with the hologram on the label is not an authentic Nokia battery, you should refrain from using it, and take it to the nearest Nokia authorized service center or dealer for assistance.

For additional information, refer to the warranty and reference leaflet included with your Nokia device.

Care and maintenance

Your device is a product of superior design and craftsmanship and should be treated with care. The following suggestions will help you protect your warranty coverage.

- Keep the device dry. Precipitation, humidity, and all types of liquids or moisture can contain minerals that will corrode electronic circuits. If your device does get wet, remove the battery, and allow the device to dry completely before replacing it.

80 Product and safety information

- Use a soft, clean, dry cloth to clean any lenses, such as camera, proximity sensor, and light sensor lenses.
- Do not use or store the device in dusty, dirty areas. Its moving parts and electronic components can be damaged.
- Do not store the device in hot areas. High temperatures can shorten the life of electronic devices, damage batteries, and warp or melt certain plastics.
- Do not store the device in cold areas. When the device returns to its normal temperature, moisture can form inside the device and damage electronic circuit boards.
- Do not attempt to open the device other than as instructed in this guide.
- Do not drop, knock, or shake the device. Rough handling can break internal circuit boards and fine mechanics.
- Do not use harsh chemicals, cleaning solvents, or strong detergents to clean the device.
- Do not paint the device. Paint can clog the moving parts and prevent proper operation.
- Use only the supplied or an approved replacement antenna. Unauthorized antennas, modifications, or attachments could damage the device and may violate regulations governing radio devices.
- Use chargers indoors.
- Always create a backup of data you want to keep, such as contacts and calendar notes.
- To reset the device from time to time for optimum performance, power off the device and remove the battery.

These suggestions apply equally to your device, battery, charger, or any accessory. If any device is not working properly, take it to the nearest authorized service facility for service.

Recycle

Always return your used electronic products, batteries, and packaging materials to a dedicated collection point. This way you help prevent uncontrolled waste disposal and promote the recycling of materials. More detailed information is available from the product retailer, local waste authorities, national producer responsibility organizations, or your local Nokia representative. Check how to recycle your Nokia products at www.nokia.com/werecycle, or if browsing on a mobile device, www.nokia.mobi/werecycle.

Additional safety information

Note: The surface of this device does not contain nickel in the platings. The surface of this device contains stainless steel.

Magnets and magnetic fields

Keep your device away from magnets or magnetic fields.

Small children

Your device and its accessories are not toys. They may contain small parts. Keep them out of the reach of small children.

Operating environment

This device meets RF exposure guidelines in the normal use position at the ear or at least 1.5 centimeters (5/8 inch) away from the body. Any carry case, belt clip, or holder for body-worn operation should not contain metal and should position the device the above-stated distance from your body.

To send data files or messages requires a quality connection to the network. Data files or messages may be delayed until such a connection is available. Follow the separation distance instructions until the transmission is completed.

Medical devices

Operation of radio transmitting equipment, including wireless phones, may interfere with the function of inadequately protected medical devices. Consult a physician or the manufacturer of the medical device to determine whether they are adequately shielded from external RF energy. Switch off your device when regulations posted instruct you to do so. Hospitals or health care facilities may use equipment sensitive to external RF energy.

Implanted medical devices

Manufacturers of medical devices recommend a minimum separation of 15.3 centimeters (6 inches) between a wireless device and an implanted medical device, such as a pacemaker or implanted cardioverter defibrillator, to avoid potential interference with the medical device. Persons who have such devices should:

- Always keep the wireless device more than 15.3 centimeters (6 inches) from the medical device.
- Not carry the wireless device in a breast pocket.
- Hold the wireless device to the ear opposite the medical device.
- Turn the wireless device off if there is any reason to suspect that interference is taking place.
- Follow the manufacturer directions for the implanted medical device.

If you have any questions about using your wireless device with an implanted medical device, consult your health care provider.

Hearing aids

Some digital wireless devices may interfere with some hearing aids.

Vehicles

RF signals may affect improperly installed or inadequately shielded electronic systems in motor vehicles such as electronic fuel injection, electronic antilock braking, electronic speed control, and air bag systems. For more information, check with the manufacturer of your vehicle or its equipment.

Only qualified personnel should service the device or install the device in a vehicle. Faulty installation or service may be dangerous and may invalidate your warranty. Check regularly that all wireless device equipment in your vehicle is mounted and operating properly. Do not store or carry flammable liquids, gases, or explosive materials in the same

82 Product and safety information

compartment as the device, its parts, or accessories. Remember that air bags inflate with great force. Do not place your device or accessories in the air bag deployment area.

Switch off your device before boarding an aircraft. The use of wireless teledevices in an aircraft may be dangerous to the operation of the aircraft and may be illegal.

Potentially explosive environments

Switch off your device in any area with a potentially explosive atmosphere. Obey all posted instructions. Sparks in such areas could cause an explosion or fire resulting in bodily injury or death. Switch off the device at refueling points such as near gas pumps at service stations. Observe restrictions in fuel depots, storage, and distribution areas; chemical plants; or where blasting operations are in progress. Areas with a potentially explosive atmosphere are often, but not always, clearly marked. They include areas where you would be advised to turn off your vehicle engine, below deck on boats, chemical transfer or storage facilities and where the air contains chemicals or particles such as grain, dust, or metal powders. You should check with the manufacturers of vehicles using liquefied petroleum gas (such as propane or butane) to determine if this device can be safely used in their vicinity.

Emergency calls

Important: This device operates using radio signals, wireless networks, landline networks and user-programmed functions. If your device supports voice calls over the internet (internet calls), activate both the internet calls and the cellular phone. The device may attempt to make emergency calls over both the cellular networks and through your internet call provider if both are activated. Connections in all conditions cannot be guaranteed. You should never rely solely on any wireless device for essential communications like medical emergencies.

To make an emergency call:

- 1 If the device is not on, switch it on. Check for adequate signal strength. Depending on your device, you may also need to complete the following:
 - Insert a SIM card if your device uses one.
 - Remove certain call restrictions you have activated in your device.
 - Change your profile from Offline or Flight profile to an active profile.
- 2 Press the end key as many times as needed to clear the display and ready the device for calls.
- 3 Enter the official emergency number for your present location. Emergency numbers vary by location.
- 4 Press the call key.

When making an emergency call, give all the necessary information as accurately as possible. Your wireless device may be the only means of communication at the scene of an accident. Do not end the call until given permission to do so.

Certification information (SAR)

This mobile device meets guidelines for exposure to radio waves.

Your mobile device is a radio transmitter and receiver. It is designed not to exceed the limits for exposure to radio waves recommended by international guidelines. These guidelines were developed by the independent scientific organization ICNIRP and include safety margins designed to assure the protection of all persons, regardless of age and health.

The exposure guidelines for mobile devices employ a unit of measurement known as the Specific Absorption Rate or SAR. The SAR limit stated in the ICNIRP guidelines is 2.0 watts/kilogram (W/kg) averaged over 10 grams of tissue. Tests for SAR are conducted using standard operating positions with the device transmitting at its highest certified power level in all tested frequency bands. The actual SAR level of an operating device can be below the maximum value because the device is designed to use only the power required to reach the network. That amount changes depending on a number of factors such as how close you are to a network base station.

The highest SAR value under the ICNIRP guidelines for use of the device at the ear is 0.73 W/kg .

Use of device accessories may result in different SAR values. SAR values may vary depending on national reporting and testing requirements and the network band. Additional SAR information may be provided under product information at www.nokia.com.

Copyright and other notices

DECLARATION OF CONFORMITY

CE 0434

Hereby, NOKIA CORPORATION declares that this RM-540 product is in compliance with the essential requirements and other relevant provisions of Directive 1999/5/EC. A copy of the Declaration of Conformity can be found at http://www.nokia.com/phones/declaration_of_conformity/.

© 2010 Nokia. All rights reserved.

Nokia, Nokia Connecting People, XpressRadio, XpressMusic, and Navi are trademarks or registered trademarks of Nokia Corporation. Nokia tune is a sound mark of Nokia Corporation. Other product and company names mentioned herein may be trademarks or tradenames of their respective owners.

Portions of the Nokia Maps software are © 1996-2010 The FreeType Project. All rights reserved.

Reproduction, transfer, distribution, or storage of part or all of the contents in this document in any form without the prior written permission of Nokia is prohibited. Nokia operates a policy of continuous development. Nokia reserves the right to make changes and improvements to any of the products described in this document without prior notice.



Includes RSA BSAFE cryptographic or security protocol software from RSA Security.



Java and all Java-based marks are trademarks or registered trademarks of Sun Microsystems, Inc.

This product is licensed under the MPEG-4 Visual Patent Portfolio License (i) for personal and noncommercial use in connection with information which has been encoded in compliance with the MPEG-4 Visual Standard by a consumer engaged in a personal and noncommercial activity and (ii) for use in connection with MPEG-4 video provided by a licensed video provider. No license is granted or shall be implied for any other use. Additional information, including that related to promotional, internal, and commercial uses, may be obtained from MPEG LA, LLC. See <http://www.mpegla.com>.

TO THE MAXIMUM EXTENT PERMITTED BY APPLICABLE LAW, UNDER NO CIRCUMSTANCES SHALL NOKIA OR ANY OF ITS LICENSORS BE RESPONSIBLE FOR ANY LOSS OF DATA OR INCOME OR ANY SPECIAL, INCIDENTAL, CONSEQUENTIAL OR INDIRECT DAMAGES HOWSOEVER CAUSED.

THE CONTENTS OF THIS DOCUMENT ARE PROVIDED "AS IS". EXCEPT AS REQUIRED BY APPLICABLE LAW, NO WARRANTIES OF ANY KIND, EITHER EXPRESS OR IMPLIED, INCLUDING, BUT NOT LIMITED TO, THE IMPLIED WARRANTIES OF MERCHANTABILITY AND FITNESS FOR A PARTICULAR PURPOSE, ARE MADE IN RELATION TO THE ACCURACY, RELIABILITY OR CONTENTS OF THIS DOCUMENT. NOKIA RESERVES THE RIGHT TO REVISE THIS DOCUMENT OR WITHDRAW IT AT ANY TIME WITHOUT PRIOR NOTICE.

The availability of particular products and applications and services for these products may vary by region. Please check with your Nokia dealer for details and availability of language options. This device may contain commodities, technology or software subject to export laws and regulations from the US and other countries. Diversion contrary to law is prohibited.

The availability of some features may vary by region. Please contact your operator for more details.

FCC/INDUSTRY CANADA NOTICE

Your device may cause TV or radio interference (for example, when using a telephone in close proximity to receiving equipment). The FCC or Industry Canada can require you to stop using your telephone if such interference cannot be eliminated. If you require assistance, contact your local service facility. This device complies with part 15 of the FCC rules. Operation is subject to the following two conditions: (1) This device may not cause harmful interference, and (2) this device must accept any interference received, including interference that may cause undesired operation. Any changes or modifications not expressly approved by Nokia could void the user's authority to operate this equipment.

Model number: X3-00

/Issue 2.0 EN-US

Index**Symbols/Numbers**

1-touch dialing	29, 38, 40
-----------------	------------

A

access codes	15
alarm clock	72
anykey answer	40
applications	66

B

backing up data	32
battery	8, 11
browser	63
business cards	72

C

cache memory	64
calculator	74
call forward	40
call log	40
call waiting	40
caller ID	40
calls	37
camera	51
camera settings	52
configuration	36
contacts	
— groups	71

— saving	70
cookies	64

D

data cable	32
dialing shortcuts	29, 38
digital rights	76
display	17, 28
downloads	22

E

e-mail	49
e-mail attachments	50
e-mail, creating	50
e-mail, reading and replying to	50
equalizer	62

F

factory settings, restoring	24
file management	54
flash messages	45
Flight profile	25
flight profile	21
font size	28

G

games	66
GPS (global positioning system)	68

H

handsfree	39
-----------	----

headset	13	memory	55
help text	25	memory card	9
home screen	18, 28	message center number	42
I			
IM	46	message sending	45
IM (instant messaging)	47, 48, 51	message settings	46
images	51, 53	messages	44
in-call timer	40	microSD cards	9
inbox, messages	44	music player	56, 57, 58
indicators	17, 19	My Nokia	22
info messages	35	N	
instant messaging	46	navigation	19
internet	63	navigation tools	69
K			
keyguard	20, 25	Nokia Ovi Suite	33
keypad lock	20	nokia software updater	23
keys	6	Nokia support information	22
L			
language settings	25	notes	74
lights	28	number mode	41
location information	35	O	
loudspeaker	39	offline mode	21
M			
mail	49	online sharing	64
mail setup	49	operator menu	35
Maps	67, 68, 69	P	
media player	54, 56, 57, 58	photographs	51
		PictBridge	32
		PIN	15
		position log	35
		predictive text input	42
		printing	54

profiles	27
PUK	15

R

radio	59, 60, 61
redial	40
restoring data	32
restoring settings	24
restriction password	15

S

screen saver	28
scrolling	19
security code	15
security module	15
security settings	26
service commands	35
sharing	64
shortcuts	18, 28
SIM	
— services	35
SIM card	8, 21
SIM messages	35
software updates	23, 25
stereo widening	63
stopwatch	75
strap	13
support resources	22
synchronization	32

T

text modes	41
themes	27
tones	25, 27
traditional text input	41
transfer music	59
transferring, files	59

U

updates	23
UPIN	15
USB data cable	32

V

video	52, 53
voice clarity	40
voice commands	29
voice dialing	38
voice recorder	61

W

wallpaper	28
web	63
write text	41