

Get started

© 2008 Nokia. All rights reserved.

Nokia, Nokia Connecting People, Nseries, N96, Navi, and Nokia Care are trademarks or registered trademarks of Nokia Corporation. Other product and company names mentioned herein may be trademarks or tradenames of their respective owners.

Reproduction, transfer, distribution, or storage of part or all of the contents in this document in any form without the prior written permission of Nokia is prohibited.

Keys and parts (front)

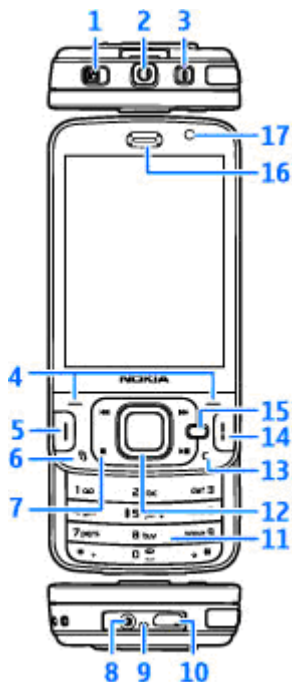

- 1 — Lock switch
- 2 — Nokia AV Connector (3.5 mm) for compatible headsets and headphones
- 3 — Power key
- 4 — Selection keys
- 5 — Call key
- 6 — Menu key 
- 7 — Media keys
- 8 — Charger connector
- 9 — Microphone
- 10 — Micro USB connector to connect to a compatible PC
- 11 — Numeric keypad
- 12 — Scroll key
- 13 — Clear key C
- 14 — End key
- 15 — Multimedia key
- 16 — Earpiece
- 17 — Secondary camera

Keys and parts (back and sides)

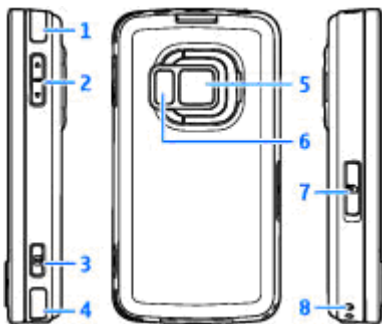

- 1 and 4 — Stereo speakers with 3-D sound effect
- 2 — Zoom/Volume key
- 3 — 2-stage capture key for auto-focus, still image capture, and video recording
- 5 — Main camera for high resolution (up to 5 megapixels) image capture and video recording
- 6 — Flash and video light
- 7 — Memory card slot for a compatible microSD card
- 8 — Hole for a wrist strap

Keys and parts (media)

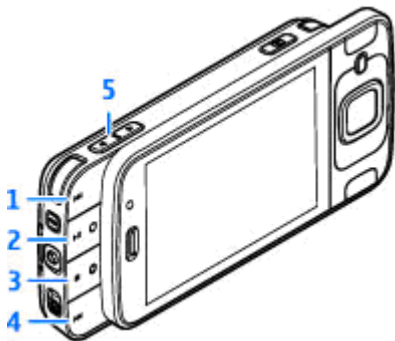

- 1 — Forward
- 2 — Play/Pause; can also be used for playing games
- 3 — Stop; can also be used for playing games
- 4 — Rewind
- 5 — Zoom/Volume key

Insert SIM card and battery

A USIM card is an enhanced version of the SIM card and is supported by UMTS mobile phones.

Always switch the device off and disconnect the charger before removing the battery.

1. With the back of the device facing you, press and hold the release button, and lift up the cover.

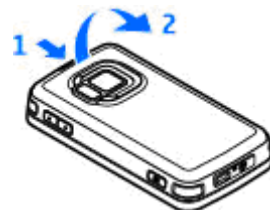

2. To release the SIM card holder, lift the holder up using the handle.
3. Insert the SIM card into the card holder. Ensure that the bevelled corner on the card is facing toward the slot, and that the contact area on the card is facing down.
4. Close the holder, and lock it into place.
5. Insert the battery.



6. To replace the cover, direct the bottom locking catches toward their slots, and press until the cover locks into place.



Switch the device on

1. Press and hold the power key.

2. If the device asks for a PIN code or lock code, enter it, and press the left selection key. The factory setting for the lock code is **12345**.

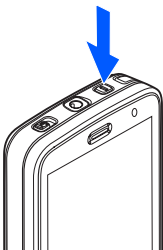

Your device may have internal and external antennas. As with any radio transmitting device, avoid touching the antenna area unnecessarily while the antenna is transmitting or receiving. Contact with such an antenna affects the communication quality and may cause the device to operate at a higher power level than otherwise needed and may reduce the battery life.

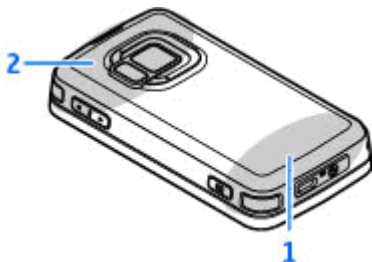

1 — Cellular antenna

2 — Antenna for Bluetooth technology, wireless LAN, and DVB-H; GPS receiver

Note that the Bluetooth, WLAN, GPS, and DVB-H antennas are located in the back cover of your device. If you change the back cover, check that the new cover includes these antennas, otherwise these connections stop working.

Charge the battery

1. Connect a compatible charger to a wall outlet.
2. Connect the power cord to the device. If the battery is completely discharged, it may take a while before the charging indicator starts scrolling.
3. When the battery is fully charged, the charging indicator stops scrolling. Disconnect the charger from the device, then from the wall outlet.



Tip: Disconnect the charger from the wall outlet when the charger is not in use. A charger that is connected to the outlet consumes power even when it is not connected to the device.

Memory card

Use only compatible microSD cards approved by Nokia for use with this device. Nokia uses approved industry standards for memory cards, but some brands may not be fully compatible with this device. Incompatible cards may damage the card and the device and corrupt data stored on the card.



Insert the memory card

Keep all memory cards out of the reach of small children. A memory card may be already inserted in the device. If not, do the following:

1. Place your finger in the recess beside the door of the memory card slot, and lift the door. Pull the door to the left to reveal the hinge, and swing the door to the side.

2. Insert a compatible memory card in the slot. Make sure that the contact area on the card is facing up and towards the slot.
3. Push the card in. You can hear a click when the card locks into place.
4. Push the hinge back in, and close the door. Ensure that the door is properly closed.



Eject the memory card



Important: Do not remove the memory card in the middle of an operation when the card is being accessed.

Removing the card in the middle of an operation may damage the memory card as well as the device, and data stored on the card may be corrupted.

1. Before you eject the card, press the power key, and select **Remove memory card**. All applications are closed.
2. When **Removing memory card will close all open applications. Remove anyway?** is displayed, select **Yes**.
3. When **Remove memory card and press 'OK'** is displayed, open the door of the memory card slot.
4. Press the memory card to release it from the slot.
5. Pull out the memory card. If the device is switched on, select **OK**.



Headset

You can connect a compatible headset or compatible headphones to your device. You may need to select the cable mode.



Warning: When you use the headset, your ability to hear outside sounds may be affected. Do not use the headset where it can endanger your safety.



To make handsfree phone calls, use a headset with a compatible remote control unit, or use the microphone on the device.

You can also connect a compatible TV-out cable to the Nokia AV Connector (3.5 mm) of your device.

Do not connect products that create an output signal as this may cause damage to the device. Do not connect any voltage source to the Nokia AV Connector.

When connecting any external device or any headset, other than those approved by Nokia for use with this device, to the Nokia AV Connector, pay special attention to volume levels.

Kickstand

You can use the kickstand when you watch TV,

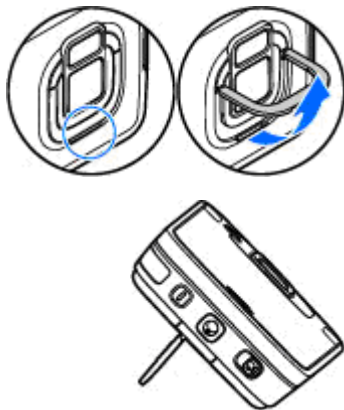

video clips, or photos, for example. Open the kickstand at the back, and place the device on a table.

Shortcuts

To switch between open applications, press and hold **0**. Leaving applications running in the background increases the demand on battery power and reduces the battery life.

To open the multimedia menu to view your multimedia content, press the multimedia key.

To start a web connection (network service), in the standby mode, press and hold **0**.

In most applications, to switch the orientation of the display from portrait to landscape, press and hold the left selection key.

In many applications, to view the most common option items (☰), press the scroll key.

To change the profile, press the power key, and select a profile.

To switch between the **General** and **Silent** profiles, in the standby mode, press and hold #.

To call your voice mailbox (network service), in the standby mode, press and hold 1.

To open the last dialled numbers list, in the standby mode, press the call key.

To use voice commands, in the standby mode, press and hold the right selection key.

Personalise your device

To customise and change the look of your device, press , and select **Tools > Settings > General > Personalisation > Themes**. You can change the theme, wallpaper, and power saver settings.

To change the shape of the main menu view, select **Menu view: Grid, List, Horseshoe, or V-shaped**.

To change the way the active toolbar is shown, press , and select **Tools > Settings > General > Personalisation > Standby mode > Standby theme**.

To view the active toolbar as a full page of events, select **Horizontal icon bar**. To view the active toolbar as vertical, select **Vertical icon bar**. To switch off the active toolbar, select **Basic**.

To change the clock shown in the standby mode, press , and select **Applications > Clock > Options > Settings > Clock type**.

To change the background image of the call bubble shown when a call comes in, select **Call image**.

Lock the keypad

When the device or keypad is locked, calls may be possible to the official emergency number programmed into your device.

To lock and unlock the keys in your device, use the lock switch at the top of the device, next to the power key. You can also unlock the keys by opening the 2-way slide.

You can set the keypad to lock automatically after a time-out.

To illuminate the keypad in low light conditions, briefly press the power key.

Display indicators

 The device is being used in a GSM network (network service).

3G The device is being used in a UMTS network (network service).

 You have one or more unread messages in the **Inbox** folder in Messaging.

 You have received new e-mail in the remote mailbox.

 There are messages waiting to be sent in the **Outbox** folder.

 You have missed calls.

 The ringing type is set to silent, and the message alert tone and e-mail alert tone are set to off.

 A timed profile is active.

 The device keypad is locked.

 A clock alarm is active.

2 The second phone line is being used (network service).

 All calls to the device are diverted to another number (network service). If you have two phone lines, a number indicates the active line.



 A compatible microSD card is in the device.



 A compatible headset is connected to the device.



 A compatible TV out cable is connected to the device.



 A compatible text phone is connected to the device.

D A data call is active (network service).

 A GPRS packet data connection is active (network service).  indicates the connection is on hold and  that a connection is available.

 A packet data connection is active in a part of the network that supports EGPRS (network service).  indicates the connection is on hold and  that a connection is available. The icons indicate that EGPRS is not necessarily using EGPRS in the data transfer.

 A UMTS packet data connection is active (network service).  indicates the connection is on hold and  that a connection is available.

 High-speed downlink packet access (HSDPA) is supported and active (network service).  indicates the connection is on hold and  that a connection is available.

Nokia Video Centre

With Nokia Video Centre (network service), you can download and stream video clips over the air from compatible internet video services using packet data or

 You have set the device to scan for wireless LANs, and a wireless LAN is available (network service).

 A wireless LAN connection is active in a network that has encryption.

 A wireless LAN connection is active in a network that does not have encryption.

 Bluetooth connectivity is on.

 Data is being transmitted using Bluetooth connectivity. When the indicator is blinking, your device is trying to connect with another device.

 A USB connection is active.

 Synchronisation is in progress.

WLAN. You can also transfer video clips from a compatible PC to your device and view them in Video centre.

Your device may have predefined services. Service providers may provide free content or charge a fee. Check the pricing in the service or from the service provider.

1. To view video clips, press , and select **Video centre**.
2. To connect to a service, select **Video directory**, and select the desired video service.
Select **Video feeds**. The device updates and displays the content available in the service.
3. To view videos by categories (if available), scroll down.

Music player



Warning: Listen to music at a moderate level. Continuous exposure to high volume may damage your hearing. Do not hold the device near your ear when the loudspeaker is in use, because the volume may be extremely loud.

Music player supports file formats such as AAC, AAC+, eAAC+, MP3, and WMA. Music player does not necessarily support all features of a file format or all the variations of file formats.

You can also use Music player to listen to podcast episodes. Podcasting is the method for delivering audio or video content over the internet using either RSS or

4. To view information about a video, select **Options > Video details**.
5. Some video clips can be streamed over the air, but others must be first downloaded to your device. To download a video clip, select **Options > Download**.
To stream a video clip or to view a downloaded clip, select **Options > Play**.
Downloads continue in the background if you exit the application. The downloaded videos are saved in **Video centre > My videos**.

Atom technologies for playback on mobile devices and PCs.

You can transfer music from other compatible devices to your device.

Play a song or a podcast episode

To open Music player, press , and select **Music > Music player**.



Tip: You can access the Music player from the multimedia menu.

You may have to refresh the music and podcast libraries after you have updated the song or podcast selection in your device. To add all available items to the library, in the Music player main view, select **Options** > **Refresh**.

To play a song or a podcast episode, do the following:

1. Select categories to navigate to the song or podcast episode you want to hear.
2. To play the selected files, press **▶**.



To pause playback, press **▶||**; to resume, press **▶||** again. To stop playback, press **■**.

To fast forward or rewind, press and hold **▶▶** or **◀◀**.

To go to the next item, press **▶▶**. To return to the beginning of the item, press **◀◀**. To skip to the previous item, press **◀◀** again within 2 seconds after a song or podcast has started.

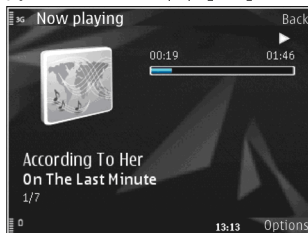

To switch random play (**⌘**) on or off, select **Options** > **Shuffle**.

To repeat the current item (**↺**), all items (**↻**), or to switch repeat off, select **Options** > **Repeat**.

If you play podcasts, shuffle and repeat are automatically switched off.

To adjust the volume, press the volume key.

To modify the tone of the music playback, select **Options** > **Equaliser**.

To modify the balance and stereo image or to enhance bass, select **Options** > **Audio settings**.

To view a visualisation during playback, select **Options** > **Show visualisation**.

To return to the standby mode and leave the player playing in the background, press the end key, or to switch to another open application, press and hold **⌘**.

To close the player, select **Options** > **Exit**.

Music menu

Press **⌘**, and select **Music** > **Music player**.

The music menu shows the available music. To view all songs, sorted songs, playlists, or podcasts in the music menu, select the desired option.

Support

Issues with your device?

If you have issues with your device or you are unsure how your device should function, refer to the online support at www.nseries.com/support or your local Nokia website www.nokia-asia.com, the Help application in the device, or the user guide. If this does not resolve your issue, try the following:

- Reset the device: switch off the device and remove the battery. After a few seconds, replace the battery, and switch on the device.
- Update your device software with Nokia Software Updater. Visit www.nokia-asia.com/softwareupdate or your local Nokia website.
- Restore the original factory settings as explained in the user guide. Your documents and files are not deleted in the reset.

If the issue remains unsolved, contact Nokia for repair options. Visit www.nokia-asia.com/repair. Before sending your device for repair, always back up or make a record of data in your device.

Online

Check www.nseries.com/support or your local Nokia website for the latest guides, additional information, downloads, and services related to your Nokia product.



Tip: You can also access the support pages from the web browser in your device.

Help

The help function provides instructions when using the device. To access it from an application, select **Options > Help**.

User guide

Refer to the user guide for other important information about your device.