

Nokia N79 Get started

© 2008 Nokia. All rights reserved.

Nokia, Nokia Connecting People, Nokia Original Enhancements logos, Nseries, N79, N-Gage, Navi, Visual Radio, and Nokia Care are trademarks or registered trademarks of Nokia Corporation. Nokia tune is a sound mark of Nokia Corporation. Other product and company names mentioned herein may be trademarks or tradenames of their respective owners.

Reproduction, transfer, distribution, or storage of part or all of the contents in this document in any form without the prior written permission of Nokia is prohibited.

Keys and parts (front)

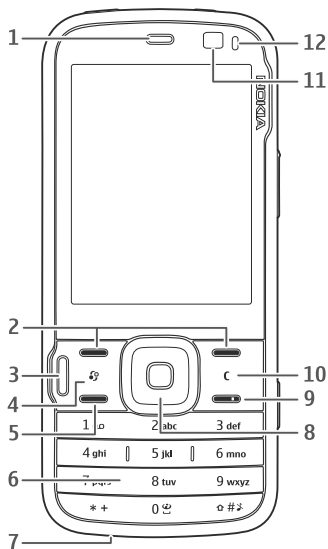

- 1 — Earpiece
- 2 — Selection keys

- 3 — Multimedia key
- 4 — Menu key 
- 5 — Call key
- 6 — Numeric keypad
- 7 — Microphone
- 8 — Navi™ wheel; hereafter referred to as the scroll key.
- 9 — End key
- 10 — Clear key C
- 11 — Secondary camera
- 12 — Light sensor

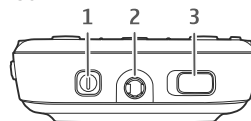

- 1 — Power key
- 2 — Nokia AV Connector for compatible headsets and headphones
- 3 — Key lock switch for locking and unlocking the keys

Keys and parts (back and sides)

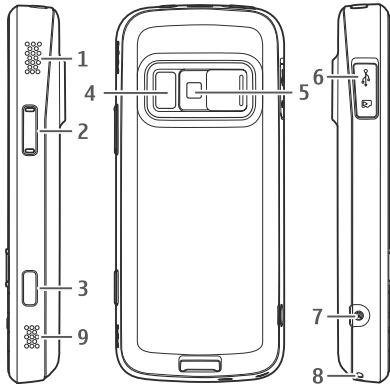

6 — Memory card slot for a compatible microSD card and Micro USB connector to connect to a compatible PC

7 — Charger connector

8 — Hole for a wrist strap

1 and 9 — Stereo speaker with 3-D sound effect

2 — Zoom/Volume key

3 — 2-stage capture key for auto-focus, still image capture, and video recording

4 — Flash and video light

5 — Main camera for high resolution (up to 5 megapixels) image capture and video recording

Insert SIM card and battery

Always switch the device off and disconnect the charger before removing the battery.

1. With the back of the device facing you, press and hold the release button and lift up the cover.
2. Insert the SIM card into the card holder. Ensure that the contact area on the card is facing down.
3. Insert the battery.

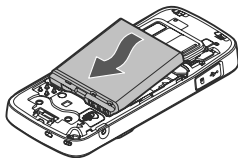
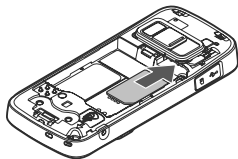
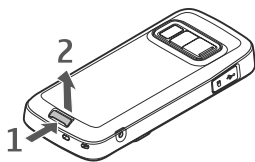

4. To replace the cover, direct the top locking catch toward its slot, and press down until the cover locks into place.

Remove SIM card

To remove the SIM card, slide the latch to the direction of the arrow.

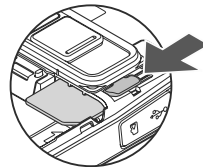
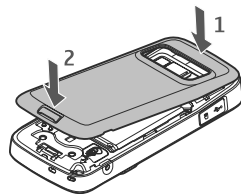

Switch the device on

1. Press and hold the power key.
2. If the device asks for a PIN code or lock code, enter it, and press the left selection key. The factory setting for the lock code is **12345**. If you forget the code and your device is locked, your device will require service and additional charges may apply. For more information, contact a Nokia Care point or your device dealer.

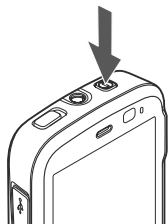

Antenna locations

Your device may have internal and external antennas. As with any radio transmitting device, avoid touching the antenna area unnecessarily while the antenna is transmitting or receiving. Contact with such an antenna affects the communication quality and may cause the device to operate at a higher power level than otherwise needed and may reduce the battery life.

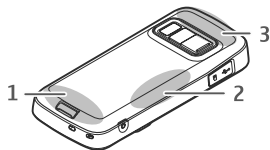

- 1 — Cellular antenna
- 2 — FM transmitter antenna
- 3 — Bluetooth and wireless LAN antenna, and GPS receiver

Memory card

Use only compatible microSD cards approved by Nokia for use with this device. Nokia uses approved industry standards for memory cards, but some brands may not be fully compatible with this device. Incompatible cards may damage the card and the device and corrupt data stored on the card.

Insert the memory card

A memory card may be already inserted in the device. If not, do the following:

1. Place your finger in the recess beside the cover of the memory card slot, and lift the cover. Pull the cover to the left to reveal the hinge, and swing the cover to the side.
2. Insert a compatible memory card in the slot. Ensure that the contact area on the card is facing down and towards the slot.

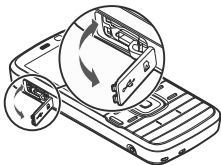

3. Push the card in. You can hear a click when the card locks into place.
4. Push the hinge back in, and close the cover. Ensure that the cover is properly closed.

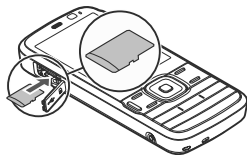

Remove the memory card



Important: Do not remove the memory card in the middle of an operation when the card is being accessed. Removing the card in the middle of an operation may damage the memory card as well as the device, and data stored on the card may be corrupted.

1. Press the power key, and select **Remove memory card**. All applications are closed.
2. When **Removing memory card will close all open applications. Remove anyway?** is displayed, select **Yes**.

3. When **Remove memory card and press 'OK'** is displayed, open the cover of the memory card slot.
4. Press the memory card to release it from the slot.
5. Pull out the memory card. If the device is switched on, select **OK**.

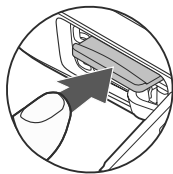

Charge the battery

1. Connect a compatible charger to a wall outlet.
2. Connect the power cord to the device. If the battery is completely discharged, it may take a while before the charging indicator starts scrolling.
3. When the battery is fully charged, the charging indicator stops scrolling. Disconnect the charger from the device, then from the wall outlet.

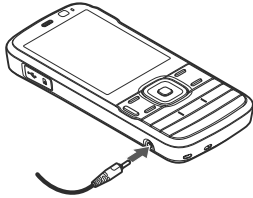

Tip: Disconnect the charger from the wall outlet when the charger is not in use. A charger that is connected to the outlet consumes power even when it is not connected to the device.

Headset

You can connect a compatible headset or compatible headphones to your device. You may need to select the cable mode.

 **Warning:** When you use the headset, your ability to hear outside sounds may be affected. Do not use the headset where it can endanger your safety.

To make handsfree phone calls, use a headset with a compatible remote control unit, or use the microphone on the device.



You can also connect a compatible TV-out cable to the Nokia AV Connector (3.5 mm) of your device.

Do not connect products that create an output signal as this may cause damage to the device. Do not connect any voltage source to the Nokia AV Connector.

When connecting any external device or any headset, other than those approved by Nokia for use with this

device, to the Nokia AV Connector, pay special attention to volume levels.

Attach wrist strap

1. Remove the back cover.
2. Thread a wrist strap, and tighten it.
3. Replace the cover.

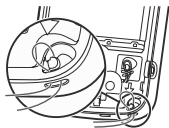

Shortcuts

To switch between open applications, press and hold **⌘**. Leaving applications running in the background increases the demand on battery power and reduces the battery life.

To view your multimedia content, press the multimedia key.

To start a web connection (network service), in the standby mode, press and hold **0**.

In many applications, to view the most common option items (**☰**), press the scroll key.

To change the profile, press the power key, and select a profile.

To switch between the General and Silent profiles, in the standby mode, press and hold **#**.

To call your voice mailbox (network service), in the standby mode, press and hold **1**.

To open a list of last dialled numbers, in the standby mode, press the call key.

To use voice commands, in the standby mode, press and hold the right selection key.

To remove an application from the menu, select it, and press **C**. Some applications may not be removed.

Display indicators

 The device is being used in a GSM network (network service).

3G The device is being used in a UMTS network (network service).

 You have one or more unread messages in the **Inbox** folder in Messaging.

 You have received new e-mail in the remote mailbox.

 There are messages waiting to be sent in the **Outbox** folder.

 You have missed calls.

 The ringing type is set to silent, and the message alert tone and e-mail alert tone are set to off.

 A timed profile is active.

 The device keypad is locked.

 A clock alarm is active.

2 The second phone line is being used (network service).

 All calls to the device are diverted to another number (network service). If you have two phone lines, a number indicates the active line.

 Your phone is connected to a network via wireless LAN or UMTS (network service) and ready for an internet call.



 A compatible microSD card is in the device.



 A compatible headset is connected to the device.

 A compatible TV out cable is connected to the device.



 A compatible text phone is connected to the device.



D A data call is active (network service).

 A GPRS packet data connection is active (network service).  indicates the connection is on hold and  that a connection is available.

 A packet data connection is active in a part of the network that supports EGPRS (network service).  indicates the connection is on hold and  that a

connection is available. The icons indicate that EGPRS is available in the network, but your device is not necessarily using EGPRS in the data transfer.

 A UMTS packet data connection is active (network service).  indicates the connection is on hold and  that a connection is available.

 High-speed downlink packet access (HSDPA) is supported and active (network service).  indicates the connection is on hold and  that a connection is available.

 You have set the device to scan for wireless LANs, and a wireless LAN is available (network service).

 A wireless LAN connection is active in a network that has encryption.

 A wireless LAN connection is active in a network that does not have encryption.

 Bluetooth connectivity is on.

 Data is being transmitted using Bluetooth connectivity. When the indicator is blinking, your device is trying to connect with another device.

 A USB connection is active.

 Synchronisation is in progress.

Lock the keypad

When the device or keypad is locked, calls may be possible to the official emergency number programmed into your device.

To lock and unlock the keys, use the lock switch at the top of the device, next to the power key.

To set the keypad to lock automatically after a time-out, press , and select **Tools** > **Settings** > **General** > **Security** > **Phone and SIM card** > **Keypad autolock period**.

To illuminate the keypad in low-light conditions, briefly press the power key.

Personalise your device

You can personalise your device by changing the standby mode, main menu, tones, themes, or font size. Most of the personalisation options, such as changing the font size, can be accessed through the device settings.

Changeable back cover

When you change the back cover of the device, the theme on the display changes to match the colour of the cover.

To change the theme automatically, you must have a compatible back cover that supports theme change.

To select, whether you want the theme to change automatically, press **Ⓜ**, and select **Tools > Settings > General > Personalisation > Themes > Theme switch**.

Modify the standby mode

To change the look of the standby mode, press **Ⓜ**, and select **Tools > Settings > General > Personalisation > Standby mode > Standby theme**. The active standby display shows application shortcuts, and events from applications such as calendar and player.

To change the selection key shortcuts or the default shortcut icons in the active standby mode, select **Tools > Settings > General > Personalisation > Standby mode > Shortcuts**. Some shortcuts may be fixed, and you cannot change them.

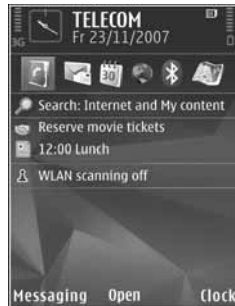

To change the clock shown in the standby mode, press **Ⓜ**, and select **Applications > Clock > Options > Settings > Clock type**.

You can also change the standby mode background image or what is shown in the power saver in the device settings.



Tip: To check whether there are applications running in the background, press and hold . To close the applications you do not use, scroll to an application in the list, and press **C**. Leaving applications running in the background increases the demand on battery power.

Multimedia menu

With the multimedia menu, you can access your most frequently used multimedia content. The selected content is shown in the appropriate application.

1. To open or close the multimedia menu, press the multimedia key.
2. To browse the tiles, scroll left or right, or, if the Navi™ wheel setting is set on, slide your finger on the rim of the scroll key.

The tiles are the following:

- **TV & video** — View your last watched video clip, video clips stored on your device, or access video services.
- **Music** — Enter Music player and the Now playing view, browse your songs and playlists, or download and manage podcasts.

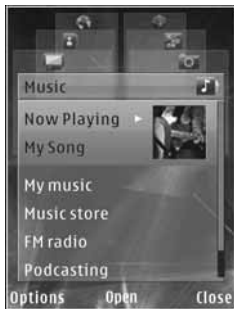

- **Images** — View your most recently taken images, start a slide show of your images or video clips, or view media files in albums.
 - **Games** — Try out N-Gage games (network service).
 - **Maps** — View your favourite locations in the Maps application.
 - **Internet** — View your favourite web links in the browser.
 - **Contacts** — Add your own contacts, send messages, or make voice calls. To add a new contact to an empty position on the list, press the scroll key, and select a contact. To send a message, in the multimedia menu, select a contact, and **Options** > **Send text message** or **Send multimedia msg..**
3. To scroll up or down in a tile, press the scroll key up or down. To select items, press the scroll key.

To change the order of the tiles, select **Options** > **Arrange tiles**.

To return to the multimedia menu from an open application, press the multimedia key.

Support

Issues with your device?

If you have issues with your device or you are unsure how your device should function, see the online support at www.nseries.com/support or your local Nokia website at www.nokia-asia.com, the Help application in the device, or the user guide. If this does not resolve your issue, try the following:

- Reset the device: switch off the device and remove the battery. After a few seconds, replace the battery, and switch on the device.
- Update your device software with Nokia Software Updater. See www.nokia-asia.com/softwareupdate or your local Nokia website.
- Restore the original factory settings as explained in the user guide. Your documents and files are not deleted in the reset.

If the issue remains unsolved, contact Nokia for repair options. See www.nokia-asia.com/repair. Before sending your device for repair, always back up or make a record of data in your device.

Online

See www.nseries.com/support or your local Nokia website for the latest guides, additional information, downloads, and services related to your Nokia product.



Tip: You can also access the support pages from the web browser in your device.

Help

The help function provides instructions when using the device. To access it from an application, select **Options > Help**.

User guide

Refer to the user guide for other important information about your device.